

Diagnóstico





11-0008	Fig. 000 =	6 mmØ	11-0028
11-0009	Fig. 00 =	8 mmØ	11-0029
11-0010	Fig. 0 =	10 mmØ	11-0030
11-0011	Fig. 1 =	12 mmØ	11-0031
11-0012	Fig. 2 =	14 mmØ	11-0032
11-0013	Fig. 3 =	16 mmØ	11-0033
11-0014	Fig. 4 =	18 mmØ	11-0034
11-0015	Fig. 5 =	20 mmØ	11-0035
11-0016	Fig. 6 =	22 mmØ	11-0036
11-0017	Fig. 7 =	24 mmØ	11-0037
11-0018	Fig. 8 =	26 mmØ	11-0038
11-0019	Fig. 9 =	28 mmØ	11-0039
11-0020	Fig.10 =	30 mmØ	11-0040

11-0025
10,0 cm/4"
Mango metálico para espejos laríngeos



Babinsky

11-0045
22 cm/8¾"

Babinsky

11-0045-01
Gummi allein
Rubber only
Gomme seul
Goma suelta



Taylor

11-0046
20 cm/8"



Berliner

11-0047
20 cm/8"

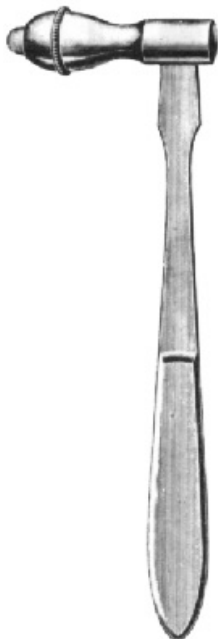

Traube

11-0048
17 cm/6¾"



Troemner

11-0049
24 cm/9½"



Martillos de percusión



Buck
11-0050
18 cm/7"



Déjerine
11-0051
20 cm/8"



Déjerine
11-0052
21 cm/8¼"

ohne Nadel
without needle
sans aiguille
sin aguja

mit Nadel
with needle
avec aiguille
con aguja

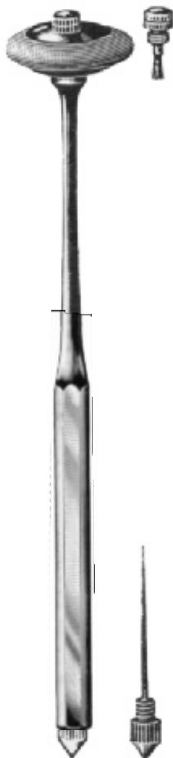

Rabiner
11-0053
23 cm/9"

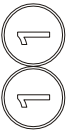

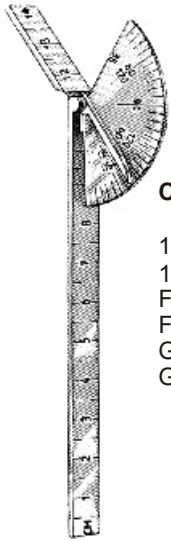

Caroll

11-0056
14,0 cm/5½"
Finger-Goniometer
Finger-Goniometer
Goniomètre
Goniómetro

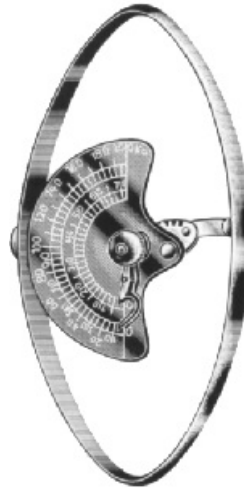

Collin

11-0057
12,5 cm/5"
Dynamometer, für Kinder
Dynamometer, for children
Dynamomètre, pour enfants
Dinamómetro, para niños

11-0058
12,5 cm/5"
Dynamometer, für Erwachsene
Dynamometer, for adults
Dynamomètre, pour adultes
Dinamómetro, para adultos



Moeltgen

11-0059
24,0 cm/9½"
Winkelmesser für die Gliedmaßen
Goniometer (Flexometer) for extremities
Goniomètre pour les membres
Goniómetro para miembros



Wartenberg

11-0060
19,0 cm/7½"
Nervrädchen
Neurological Pinwheel
Roue neurologique
Instrumento para examen neurológico



Instrumentos para exámenes y medidas

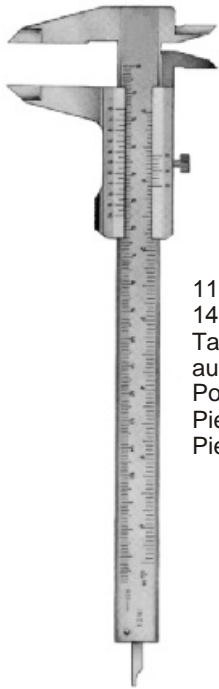

11-0061
14,0 cm/5½"
Taschen-Meßschieber
aus nichtrostendem Stahl
Pocket Slide Caliper, of stainless steel
Pied à coulisse de poche, en acier inoxydable
Pie de rey de bolsillo, de acero inoxidable

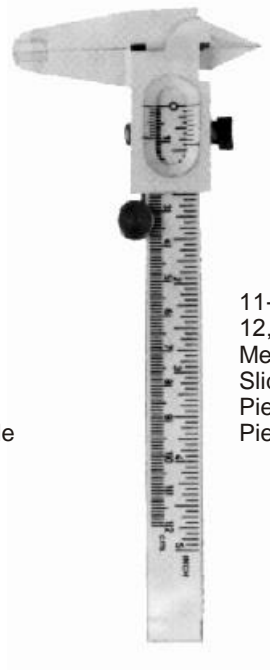

11-0062
12,0 cm/5"
Meßschieber aus Kunststoff
Slide Caliper of synthetic material
Pied à coulisse, en matière synthétique
Pie de rey, en materia sintética



11-0064
1,5 m
Bandmaß in Metallkapsel
aus Wachstuch/Leinen
Tape Measure in metal case
of oil cloth
Metre à ruban dans une boîte de métal
en toile cirée
Cinta métrica en cápsula metálica
de tela encerada

11-0065
2,0 m
aus Stahl
of steel
en acier
de acero



Metall-aMeßstab mit Millimereinteilung
Metal Rule graduated in millimeters and inches
Règle en métal divisé en centimètres et pouces
Regla métrica de metal graduada en milímetros y pulgadas

11-0066 15,0 cm/6"
11-0067 20,0 cm/8"
11-0068 30,0 cm/12"
11-0069 50,0 cm/20"



11-0070 15,0 cm/6"



Pinard

11-0071 30,0 cm/12"
 11-0072 18,0 cm/7"
 aus Holz
 of wood
 en bois
 de madera



Pinard

11-0073 15,0 cm/6"
 aus Aluminium
 of aluminium
 en aluminium
 de aluminio

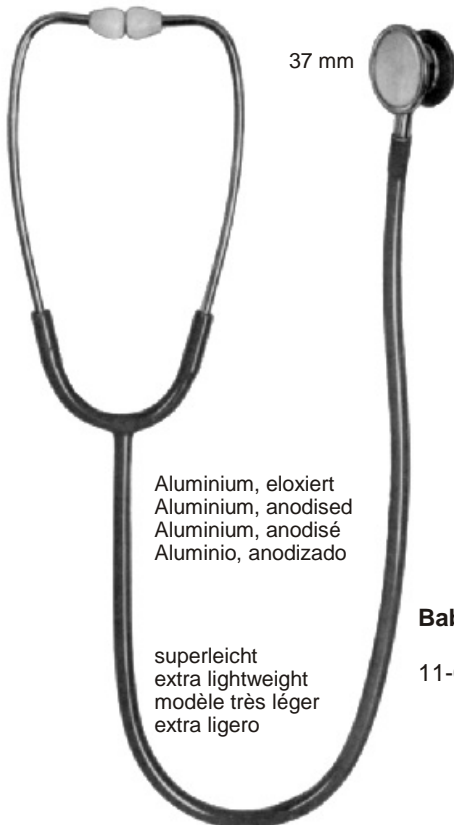

37 mm

Aluminium, eloxiert
 Aluminium, anodised
 Aluminium, anodisé
 Aluminio, anodizado

superleicht
 extra lightweight
 modèle très léger
 extra ligero

Baby-Duplex

11-0075

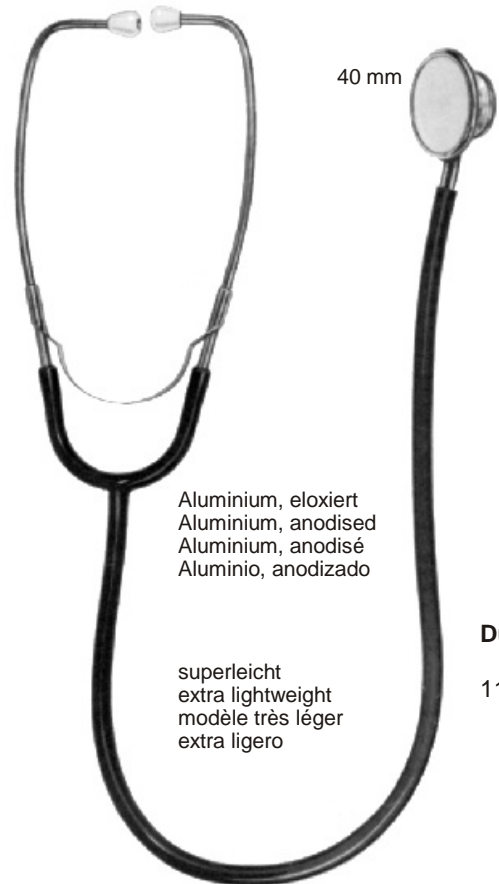

40 mm

Aluminium, eloxiert
 Aluminium, anodised
 Aluminium, anodisé
 Aluminio, anodizado

superleicht
 extra lightweight
 modèle très léger
 extra ligero

Duplex

11-0076





47 mm

Anestophon

11-0077



Rirap

11-0078

Drei verschiedene austauschbare Trichteransätze
Three additional interchangeable bell-type pieces
Trois pièces supplémentaires interchangeables
Tres diferentes piezas adicionales intercambiables
en forma de embudo



aus rostfreiem Stahl
stainless steel
en acier inoxydable
de acero inoxidable

Cardiophon

11-0079

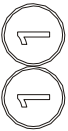

Manómetros para la presión de la sangre

Diplomat Presameter

11-0080
Quecksilbergerät
Mercury apparatus
Appareil de mercure
Tensiómetro de mercurio

mit Hakenmanschette
with hook cuff
avec manchette à crochets
con brazalete a ganchos

11-0081
mit Velcromanschette
with velcro cuff
avec manchette velcro
con brazalete velcro

Empire

11-0082
Quecksilbergerät
Mercury apparatus
Appareil de mercure
Tensiómetro de mercurio

mit Hakenmanschette
with hook cuff
avec manchette à crochets
con brazalete a ganchos

11-0083
mit Velcromanschette
with velcro cuff
avec manchette velcro
con brazalete velcro

Manómetros para la presión de la sangre



Precisa

11-0084
Einhandmodel
One hand model
Modèle à main
Modelo a mano

mit Velcromanschette
with velcro cuff
avec manchette velcro
con brazaletes velcro

Minimus III

11-0085
Einhandmodel
One hand model
Modèle à main
Modelo a mano

mit Hakenmanschette
with hook cuff
avec manchette à crochets
con brazaletes a ganchos

11-0086
mit Velcromanschette
with velcro cuff
avec manchette velcro
con brazaletes velcro



Lámparas frontales



11-0119
Stirnband aus Plastik
Head band of plastic
Bandeau de plastique
Cinta de plástico

11-0122
Ersatzspiegel, 100 mm Ø
Mirror only, 100 mm Ø
Miroir seul, 100 mm Ø
Espejo suelto, 100 mm Ø

Clar
Stirnlampe
Head Lamp
Eclaireur frontal
Lámpara frontal

11-0118
mit Stirnband aus Plastik, 100 mm Ø
with head band of plastic, 100 mm Ø
avec bandeau de plastique, 100 mm de Ø
con cinta de plástico, 100 mm de Ø

11-0120
mit Stirnband aus Celluloid, 100 mm Ø
with head band of celluloid, 100 mm Ø
avec bandeau de celluloid, 100 mm de Ø
con cinta de celuloide, 100 mm de Ø

11-0121
Stirnband aus Celluloid
Head band of celluloid
Bandeau de celluloid
Cinta de celuloide

11-0123
Ersatz-Birnchen, 6 V
Spare bulb, 6 V
Lampe de rechange, 6 V
Bombillas de repuesto, 6 V



Clar
Stirnlampe
Head Lamp
Eclaireur frontal
Lámpara frontal

11-0124
mit Stirnband aus Celluloid
with head band of celluloid
avec bandeau de celluloid
con cinta de celuloide

11-0125
Stirnband aus Celluloid
Head band of celluloid
Bandeau de celluloid
Cinta de celuloide



11-0126
Ersatzspiegel, 100 mm Ø
Mirror only, 100 mm Ø
Miroir seul, 100 mm Ø
Espejo suelto, 100 mm Ø



11-0127
Ersatz-Birnchen, 6 V
Spare bulb, 6 V
Lampe de rechange, 6 V
Bombillas de repuesto, 6 V





Schioetz
 Tonometer, Spez. 5
 Tonometer, Spec. 5
 Tonomètre, Spécif. 5
 Tonómetro, Spec. 5

11-0130
 gerade Skala
 straight scale
 cadre droit
 escala recta

11-0131
 schräge Skala
 inclined scale
 cadre courbe
 escala inclinada

11-0132
 Eichgebühr
 rate for gauging
 droits pour étalonnage
 precio para aforo

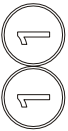



Schukze

11-0135
20,0 cm/8"
Salpingograph, komplett
Salpingograph, complete
Salpingographe, complet
Salpingografo, completo



Aparato de compresión

11-0136
Komprimeter
Comprimeter
Appareil compressif complet
Aparato de compresión

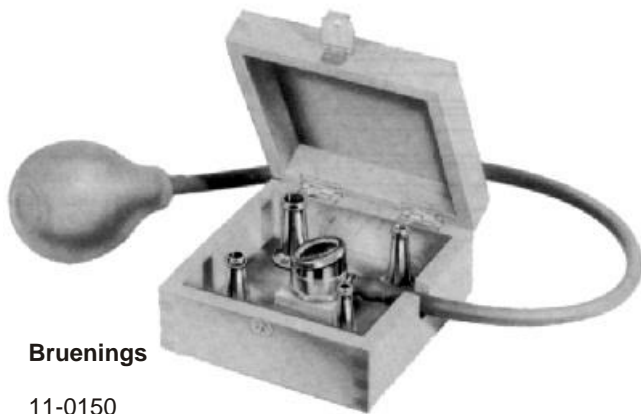

Bruenings

11-0150
Ohrspekula, komplett
Ear Specula, complete
Spéculum auriculaire, complet
Espéculo auricular, completo

11-0156
Gummiball mit Schlauch, allein
Rubber Bulb and tube, only
Poire soufflante et tube, seule
Insuflador con tubo, solo

11-0157
Holzetui, allein
Wooden Case, only
Boîte en bois, seule
Estuche de madera, solo



11-0155
Kopfstück, allein
Head piece, only
Pièce de tête, seule
Pieza de cabeza, solo



Fig. 1
11-0151
6 mm Ø
¼

Fig. 2
11-0152
7,5 mm Ø
¼

Fig. 3
11-0153
8,2 mm Ø
¼

Fig. 4
11-0154
10 mm Ø
¼

Hartmann

Ohrspekula
Ear Specula
Spéculum auriculaire
Espéculo auricular



Fig. 0
11-0160
3,0 mm Ø
¼

Fig. 1
11-0161
4,0 mm Ø
¼

Fig. 2
11-0162
5,0 mm Ø
¼

Fig. 3
11-0163
6,0 mm Ø
¼

Fig. 4
11-0164
7,5 mm Ø
¼

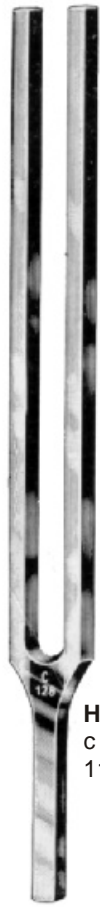

Hartmann
c 128
11-0180-00



Hartmann
c¹ 256
11-0180-01



Hartmann
c² 512
11-0180-02



Hartmann
c³ 1024
11-0180-03



Hartmann
c⁴ 2048
11-0180-04



Hartmann
c⁵ 4096
11-0180-05

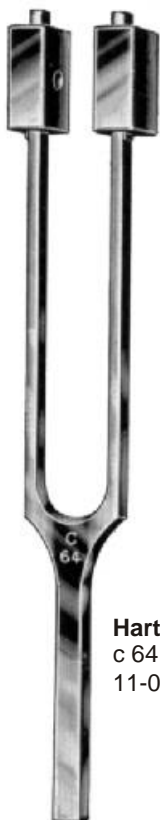

Hartmann
c 64
11-0180-06

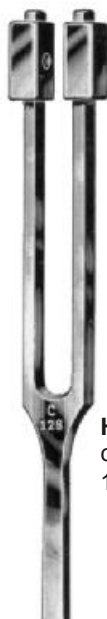

Hartmann
c 128
11-0180-07



Hartmann
c¹ 256
11-0180-08



Hartmann
mit Fuß, with foot
avec pied, con pie
c¹ 256
11-0180-09

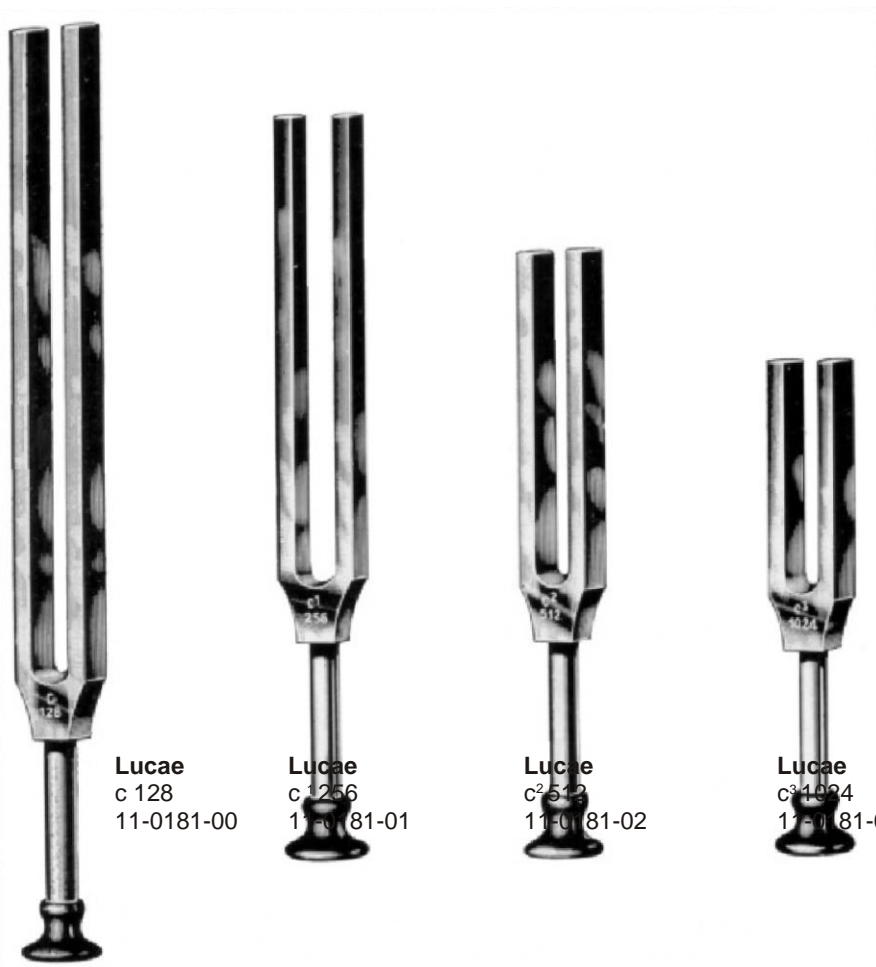

Lucae
c 128
11-0181-00

Lucae
c 256
11-0181-01

Lucae
c 512
11-0181-02

Lucae
c 1024
11-0181-03



Lucae
c 42048
11-0181-04



Lucae
c 54096
11-0181-05



Lucae
c 118
11-0181-06



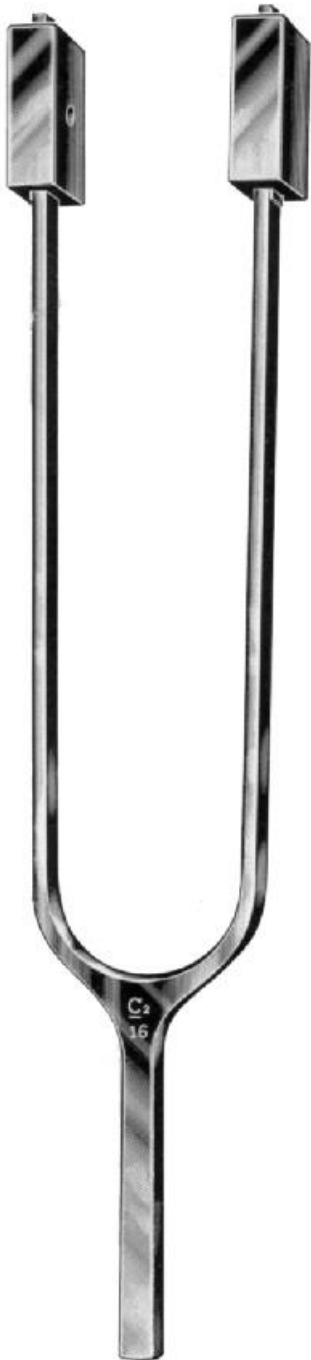

French
 c₋₂ 16
 Doppel-Contra
 Double-contra
 Double-contra
 Doble-contra

11-0182-01



French
 c₋₁ 32
 Contra
 Contra
 Contra
 Contra

11-0182-02



Rydel-Seiffer
 C 64 / c 128
 mit Dämpfern = C 64 / ohne Dämpfer = c 128
 with clamps = C 64 / without clamps = c 128
 avec curseurs = C 64 / sans curseurs = c 128
 con sordinas = C 64 / sin sordinas = c 128

11-0183-01





Stimmgabel für neurologische Untersuchungen, mit Reflexhammer, Nadelrad, Pinsel und Nadel

Tuning fork for neurological examinations, with percussion hammer, pinwheel, brush, and needle

Diapason pour examens neurologiques, avec marteaux-percuteurs, roue aux épingles, brosse et aiguille

Diapasón para exámenes neurológicos, con martillo percusor, rueda con espinas, cepillo y aguja

11-0184-01

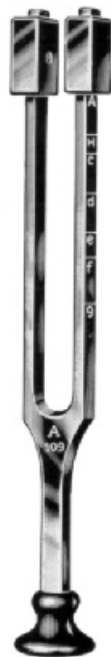

Koenig
A 109
verschiebbar bis g
variable up to g
variable jusqu' à g
variable hasta g

11-0185-01



a' 440
11-0186-01



A 218
11-0186-02



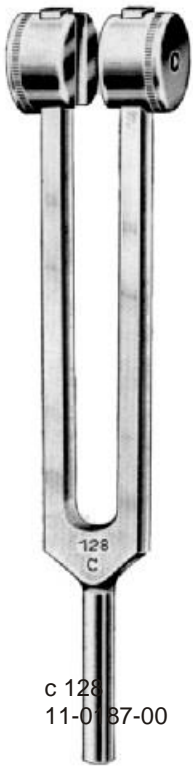

c 128
11-0187-00



c 256
11-0187-01

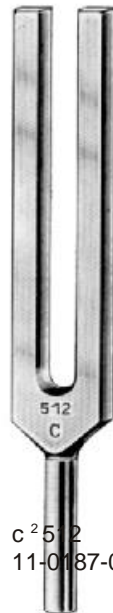

c 512
11-0187-02



c 1024
11-0187-03



c 2048
11-0187-04

Stimmgabeln aus Spezial Aluminium-Magnesium-Legierung für medizinische Zwecke z. B. für Gehörprüfungen (Luft- und Knochenleitung), für Sensibilitätsprüfungen und andere diagnostische Zwecke.

Tuning forks made from special aluminium-magnesium-alloy, for medical purposes, such as examination of hearing (air and bone conduction), for sensibility examinations, and other diagnostic purposes.

Diapasons faits d' un alliage spécial d' aluminium et de magnésium, à des fins médicales, telles que l' examen de l' ouïe (conduite de l' air et os) et l' examen de la sensibilité et tout autre diagnostique.

Diapasón de una aleación especial al aluminio y magnesio, destinado a fines médicos por ejemplo, reconocimiento del oído (conduito del aire y huesos), reconocimiento de la sensibilidad y otros fines diagnósticos.



11-0188-00
Satz zu 5 Spezial Aluminium-Magnesium-Legierung Stimmgabeln im Etui
Set of 5 special aluminium-magnesium-alloy tuning forks in a case
Jeu de 5 diapasons, alliage spécial aluminium/magnésium dans un étui
Juego de 5 diapasones de una aleación especial de aluminio y magnesio en estuche
(11-0187-00, 11-0187-01, 11-0187-02, 11-0187-03, 11-0187-04)



11-0189-05
Satz zu 5 Hartmann Stimmgabeln im Etui
Set of 5 Hartmann tuning forks in a case
Jeu de 5 Hartmann diapasons dans un étui
Juego de 5 Hartmann diapasones en estuche
(11-0180-02, 11-0180-03, 11-0180-04, 11-0180-07, 11-0180-08)





11-0189-06
Satz zu 6 Hartmann Stimmgabeln im Etui
Set of 6 Hartmann tuning forks in a case
Jeu de 6 Hartmann diapasons dans un étui
Juego de 6 Hartmann diapasones en estuche
(11-0180-02, 11-0180-03, 11-0180-04,
11-0180-05, 11-0180-07, 11-0180-08)



11-0189-08
Satz zu 8 Hartmann Stimmgabeln im Etui
Set of 8 Hartmann tuning forks in a case
Jeu de 8 Hartmann diapasons dans un étui
Juego de 8 Hartmann diapasones en estuche
(11-0180-02, 11-0180-03, 11-0180-04, 11-0180-05,
11-0180-06, 11-0180-07, 11-0180-08, 11-0182-02)



Pinzas



Schweizer Pinzetten, extra fein
Fine Swiss Tweezers
Brucelles suisses
Pinzas suizas



0,3 mm

12-0101



0,3 mm

12-0102



0,2 mm

12-0103



0,2 mm

12-0104



0,15 mm

12-0105



0,2 mm

12-0106



0,25 mm

12-0107

12

Anatomische Pinzetten
Dressing Forceps
Pinces à dissection
Pinzas de disección



Standard

12-0199	10,5 cm/4¼"
12-0200	11,5 cm/4½"
12-0201	13,0 cm/5"
12-0202	14,5 cm/5½"
12-0203	16,0 cm/6¼"
12-0204	18,0 cm/7"
12-0205	20,0 cm/8"
12-0206	25,0 cm/10"
12-0207	30,0 cm/12"

12-0205L 20,0 cm/8"
 Isoliert für Laser- und Elektrochirurgie
 insulated for Laser- and Electrosurgery
 isolé pour les interventions au laser et
 électrochirurgical
 aislado para láser y electrocirugía



Standard

gebogen, curved
 courbe, curvas

12-0209	10,5 cm/4¼"
12-0210	11,5 cm/4½"
12-0211	13,0 cm/5"
12-0212	14,5 cm/5½"
12-0213	16,0 cm/6¼"
12-0214	18,0 cm/7"
12-0215	20,0 cm/8"
12-0216	25,0 cm/10"
12-0217	30,0 cm/12"



schmal, narrow
 étroite, estrechas

12-0220	11,5 cm/4½"
12-0221	13,0 cm/5"
12-0222	14,5 cm/5½"
12-0223	16,0 cm/6¼"
12-0224	18,0 cm/7"
12-0225	20,0 cm/8"
12-0226	25,0 cm/10"
12-0227	30,0 cm/12"



schmal, narrow
 étroite, estrechas

12-0230	11,5 cm/4½"
12-0231	13,0 cm/5"
12-0232	14,5 cm/5½"
12-0233	16,0 cm/6¼"
12-0234	18,0 cm/7"
12-0235	20,0 cm/8"
12-0236	25,0 cm/10"
12-0237	30,0 cm/12"



fein, delicate
 fine, finas

12-0241	13,0 cm/5"
12-0242	14,5 cm/5½"



Schwedisches Modell
Swedish pattern
Modèle suédois
Modelo sueco

12-0247	13,0 cm/5"
12-0248	15,0 cm/6"
12-0249	17,0 cm/6¾"

Anatomische Pinzetten
Dressing Forceps
Pinces à dissection
Pinzas de disección



USA-Mod. Standard

12-0250	12,0 cm/4 ³ / ₄ "
12-0251	13,0 cm/5"
12-0252	14,5 cm/5 ¹ / ₂ "
12-0253	15,5 cm/6"
12-0254	18,0 cm/7"
12-0255	21,0 cm/8 ¹ / ₄ "
12-0256	25,0 cm/10"
12-0257	31,0 cm/12 ¹ / ₄ "



USA Mod

schmal, narrow

étroite, estrechas

12-0260	12,0 cm/4 ³ / ₄ "
12-0261	13,0 cm/5"
12-0262	14,5 cm/5 ¹ / ₂ "
12-0263	15,5 cm/6"



engl. Mod.

12-0265	13,0 cm/5"
12-0266	14,5 cm/5 ¹ / ₂ "
12-0267	15,5 cm/6"

12



Semken

12-0271	12,5 cm/5"
12-0272	15,0 cm/6"



Adson

Micro 0,8 mm

12-0274 12,0 cm/4³/₄"

1,2 mm

12-0275 12,0 cm/4³/₄"



Mc Indoe

12-0277	15,0 cm/6"
---------	------------

Anatomische Pinzetten
 Dressing Forceps
 Pincès à dissection
 Pinzas de disección



Potts-Smith

- 12-0280 18,0 cm/7"
- 12-0281 21,0 cm/8 1/4"
- 12-0282 25,0 cm/10"



Potts-Smith

- gebogen, curved
 courbe, curvas
- 12-0283 18,0 cm/7"
 - 12-0284 21,0 cm/8 1/4"
 - 12-0285 25,0 cm/10"



Gerald

- 12-0288 18,0 cm/7"

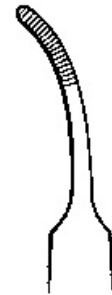

Gerald

- gebogen, curved
 courbe, curvas
- 12-0289 18,0 cm/7"



Taylor

- 12-0290 17,5 cm/7"



Taylor

- gebogen, curved
 courbe, curvas
- 12-0291 17,5 cm/7"



Taylor

- 12-0292 17,5 cm/7"



Taylor

- gebogen, curved
 courbe, curvas
- 12-0293 17,5 cm/7"

Anatomische Pinzetten
Dressing Forceps
Pinces à dissection
Pinzas de disección



Waugh

12-0294 15,0 cm/6"
 12-0295 20,0 cm/8"



Brophy

12-0296 20,0 cm/8"



Brophy

gebogen, curved
 courbe, curvas
 12-0297 20,0 cm/8"

12



Cushing

12-0298 17,5 cm/7"



Cushing

gebogen, curved,
 courbe, curvas
 12-0299 17,5 cm/7"

Chirurgische Pinzetten
Tissue Forceps
Pinces à dissection à griffes
Pinzas de disección con dientes



1:2

12-0308	10,5 cm/4 ¹ / ₄ "
12-0300	11,5 cm/4 ¹ / ₂ "
12-0301	13,0 cm/5"
12-0302	14,5 cm/5 ¹ / ₂ "
12-0303	16,0 cm/6 ¹ / ₄ "
12-0304	18,0 cm/7"
12-0305	20,0 cm/8"
12-0306	25,0 cm/10"
12-0307	30,0 cm/12"



2:3

12-0310	11,5 cm/4 ¹ / ₂ "
12-0311	13,0 cm/5"
12-0312	14,5 cm/5 ¹ / ₂ "
12-0313	16,0 cm/6 ¹ / ₄ "
12-0314	18,0 cm/7"
12-0315	20,0 cm/8"
12-0316	25,0 cm/10"
12-0317	30,0 cm/12"



3:4

12-0321	13,0 cm/5"
12-0322	14,5 cm/5 ¹ / ₂ "
12-0323	16,0 cm/6 ¹ / ₄ "



4:5

12-0327	13,0 cm/5"
12-0328	14,5 cm/5 ¹ / ₂ "
12-0329	16,0 cm/6 ¹ / ₄ "



1:2

schmal, narrow
 étroite, estrechas

12-0331	13,0 cm/5"
12-0332	14,5 cm/5 ¹ / ₂ "
12-0333	16,0 cm/6 ¹ / ₄ "
12-0335	20,0 cm/8"



USA-Mod. 1:2

12-0340	12,0 cm/4 ³ / ₄ "
12-0341	13,0 cm/5"
12-0342	14,5 cm/5 ¹ / ₂ "
12-0343	15,5 cm/6"
12-0344	18,0 cm/7"
12-0345	21,0 cm/8 ¹ / ₄ "
12-0346	25,0 cm/10"
12-0347	31,0 cm/12 ¹ / ₄ "



USA-Mod. 2:3

12-0350	12,0 cm/4 ³ / ₄ "
12-0351	13,0 cm/5"
12-0352	14,5 cm/5 ¹ / ₂ "
12-0353	15,5 cm/6"
12-0354	18,0 cm/7"
12-0355	21,0 cm/8 ¹ / ₄ "
12-0356	25,0 cm/10"
12-0357	31,0 cm/12 ¹ / ₄ "

Chirurgische Pinzetten
Tissue Forceps
Pinces à dissection à griffes
Pinzas de disección con dientes



USA-Mod.
 fein, delicate
 fine, finas

12-0371	13,0 cm/5"
12-0372	14,5 cm/5½"
12-0373	15,0 cm/6"



Adlerkreutz

2:3

4:5

15 cm/6"	12-0374-15	12-0375-15
20 cm/8"	12-0374-20	12-0375-20
25 cm/10"	12-0374-25	12-0375-25

12



Semken

12-0381	12,5 cm/5"
12-0382	15,0 cm/6"



Adson

Micro 0,8 mm

12-0384	12,0 cm/4½"
12-0384-15	15,0 cm/6"

1,2 mm

12-0385	12,0 cm/4½"
12-0385-15	15,0 cm/6"

Chirurgische Pinzetten
 Tissue Forceps
 Pinces à dissection à griffes
 Pinzas de disección con dientes



Adson Brown
 9 x 9
 12-0386 12,0 cm/4½"



Gillies
 12-0387 15,0 cm/6"



Gerald
 12-0388 17,5 cm/7"



Gerald
 gebogen, curved
 courbe, curvas
 12-0389 17,5 cm/7"

Chirurgische Pinzetten
 Tissue Forceps
 Pincès à dissection à griffes
 Pinzas de disección con dientes



Taylor

12-0390 17,5 cm/7"



Taylor

gebogen, curved,
 courbe, curvas
 12-0391 17,5 cm/7"



Cushing

12-0392 17,5 cm/7"



Cushing

gebogen, curved,
 courbe, curvas
 12-0393 17,5 cm/7"

12



Brophy

12-0394 20,0 cm/8"



Brophy

gebogen, curved,
 courbe, curvas
 12-0395 20,0 cm/8"



Waugh

12-0396 15,0 cm/6"
 12-0397 20,0 cm/8"

Chirurgische Pinzetten
 Tissue Forceps
 Pincès à dissection à griffes
 Pinzas de disección con dientes



Taylor

12-0398 17,5 cm



Taylor

12-0399 17,5 cm/7"



Potts-Smith

12-0400 18,0 cm/7"
 12-0401 21,0 cm/8¼"
 12-0402 25,0 cm/10"



Potts-Smith

gebogen, curved,
 courbe, curvas

12-0403 18,0 cm/7"
 12-0404 21,0 cm/8¼"
 12-0405 25,0 cm/10"



Lane 1:2

12-0407 14,5 cm/5½"
 12-0408 18,0 cm/7"



Lane 2:3

12-0409 14,5 cm/5½"
 12-0410 18,0 cm/7"



Bonney 1:2

12-0411 18,0 cm/7"



Bonney 2:3

12-0412 18,0 cm/7"



Thorax-Pinzetten
Lung grasping Forceps
Pinces pour saisir le poumon
Pinzas para coger el pulmón



Mod. Russ.

- 12-0413 15,0 cm/6"
- 12-0414 20,0 cm/8"
- 12-0415 25,0 cm/10"



Singley-Tuttle

- 12-0416 23,0 cm/9"



Nelson

- 12-0417 23,0 cm/9"



Mod. Mayo-Russ.

- 12-0419 23,0 cm/9"

1
2

Atrauma-Pinzetten
Atrauma Forceps
Pinces atraumatiques
Pinzas atraumáticas



De Bakey
gerade, straight,
droite, rectas

	1,5 mm	2,0 mm	2,7 mm	3,5 mm
16,0 cm/6¼"	12-0420-16	12-0421-16	12-0422-16	12-0423-16
20,0 cm/8"	12-0420-20	12-0421-20	12-0422-20	12-0423-20
24,0 cm/9½"	12-0420-24	12-0421-24	12-0422-24	12-0423-24
30,0 cm/12"	12-0420-30	12-0421-30	12-0422-30	12-0423-30



De Bakey
abgewinkelt, angular,
angulaire, angulares

	2,0 mm
16,0 cm/6¼"	12-0424-16
20,0 cm/8"	12-0424-20
24,0 cm/9½"	12-0424-24
30,0 cm/12"	12-0424-30



Anatomische Pinzetten, fein
Dressing Forceps, delicate
Pincès à dissection, fines
Pinzas de disección, finas



12-0425 10,5 cm/4½"

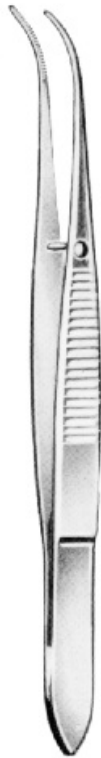

12-0426 10,5 cm/4½"



12-0427 10,5 cm/4½"

12

Chirurgische Pinzetten, fein
Tissue Forceps, delicate
Pincès à dissection à griffes, fines
Pinzas de disección con dientes, finas



12-0428 10,5 cm/4½"



12-0429 10,5 cm/4½"



12-0430 10,5 cm/4½"

Splitterpinzetten
Splinter Forceps
Pinces à échardes
Pinzas para espinas



glatt, smooth
 lisse, lisas
 ohne Stift, without pin
 sans cheville, sin perno

12-0431	8,0 cm/3¼"
12-0432	9,0 cm/3½"
12-0433	10,5 cm/4¼"
12-0434	11,5 cm/4½"
12-0435	12,5 cm/5"
12-0436	8,0 cm/3¼"
12-0437	9,0 cm/3½"
12-0438	10,5 cm/4¼"
12-0439	11,5 cm/4½"
12-0440	12,5 cm/5"



gerieft, serrated
 striée, estriadas
 ohne Stift, without pin
 sans cheville, sin perno

12-0441	8,0 cm/3¼"
12-0442	9,0 cm/3½"
12-0443	10,5 cm/4¼"
12-0444	11,5 cm/4½"
12-0445	12,5 cm/5"
12-0446	8,0 cm/3¼"
12-0447	9,0 cm/3½"
12-0448	10,5 cm/4¼"
12-0449	11,5 cm/4½"
12-0450	12,5 cm/5"

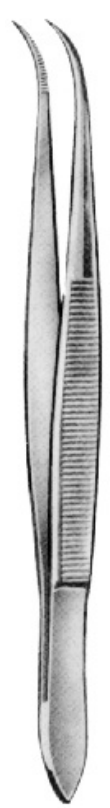

12



glatt, smooth
 lisse, lisas
 mit Stift, with pin
 avec cheville, con perno

12-0451	8,0 cm/3¼"
12-0452	9,0 cm/3½"
12-0453	10,5 cm/4¼"
12-0454	11,5 cm/4½"
12-0455	12,5 cm/5"
12-0456	8,0 cm/3¼"
12-0457	9,0 cm/3½"
12-0458	10,5 cm/4¼"
12-0459	11,5 cm/4½"
12-0460	12,5 cm/5"



gerieft, serrated
 striée, estriadas
 mit Stift, with pin
 avec cheville, con perno

12-0461	8,0 cm/3¼"
12-0462	9,0 cm/3½"
12-0463	10,5 cm/4¼"
12-0464	11,5 cm/4½"
12-0465	12,5 cm/5"
12-0466	8,0 cm/3¼"
12-0467	9,0 cm/3½"
12-0468	10,5 cm/4¼"
12-0469	11,5 cm/4½"
12-0470	12,5 cm/5"



Splitterpinzetten
Splinter Forceps
Pinces à échardes
Pinzas para espinas



Feilchenfeld

- 12-0471 7,5 cm/3"
- 12-0472 9,0 cm/3½"
- 12-0473 11,5 cm/4½"



Hunter

- 12-0474 10,5 cm/4¼"



Hunter

- 12-0475 10,5 cm/4¼"



Walter-Carmalt

- 12-0476 10,5 cm/4¼"



Walter-Carmalt

- 12-0477 10,5 cm/4¼"

Mikroskopierpinzetten
Microscope Forceps
Pinces pour microscopier
Pinzas para el microscopio



- 12-0485 10,0 cm/4"
- stumpf
- blunt
- mousse
- romas



- 12-0486 10,0 cm/4"
- spitz
- sharp
- pointue
- agudas



Tumorpinzetten
Tumor Forceps
Pinces à tumeurs
Pinzas para tumores



Yasargil
22,0 cm/8³/₄"
glatt, smooth,
lisse, lisas



Ø 3 mm Ø 5 mm
12-0487-03 12-0487-05



Yasargil
22,0 cm/8³/₄"
gerieft, serrated,
striée, estriadas



Ø 3 mm Ø 5 mm
12-0488-03 12-0488-05



Heifetz
22,0 cm/8³/₄"
gerieft, serrated,
striée, estriadas

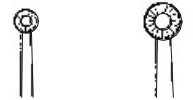

Ø 3 mm Ø 5 mm
12-0489-03 12-0489-05

12

Cilienpinzetten
Cilia Forceps
Pinces à épiler les cils
Pinzas depilatorias



Beer

12-0491 8,0 cm/3¼"
120492 9,0 cm/3½"



Littauer

12-0493 8,5 cm/3½"



Douglas

schmal, narrow,
étroite, estrechas
12-0494-01 9,0 cm/3½"



Douglas

breit, broad,
large, anchas
12-0494-02 9,0 cm/3½"

Deckglaspinzetten
Cover Glass Forceps
Pinces porte-lamelles
Pinzas para cubrir objetos



Kuehne

12-0495-01
10,5 cm/4¼"
gerade
straight
droite
rectas

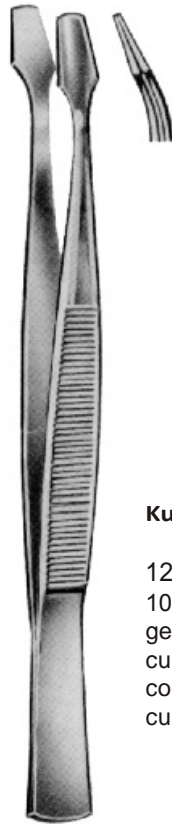

Kuehne

12-0495-02
10,5 cm/4¼"
gebogen
curved
courbe
curvas



Kuehne

12-0495-03
10,5 cm/4¼"
überkreuzt
curved crossed
courbe croisée
curvas cruzadas



12-0496
10,5 cm/4¼"

12

Splitterzangen
Splinter Forceps
Pinces à échardes
Pinzas para espinas

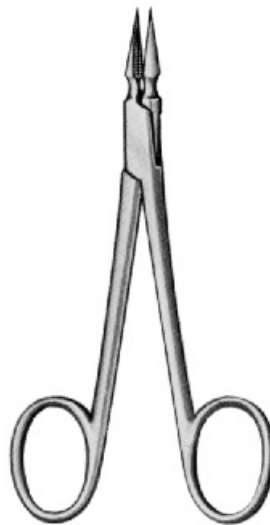

Splitterzangen
Splinter Forceps
Pinces à échardes
Pinzas para espinas

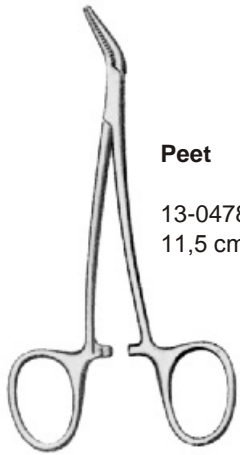

Peet

13-0478
 11,5 cm/4½"

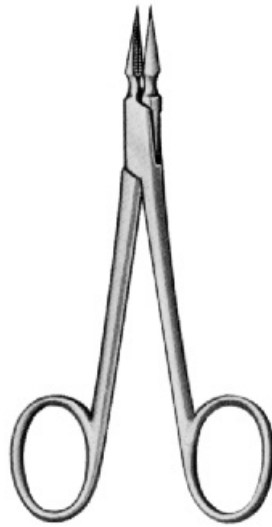

Arthur

13-0479
 13,5 cm/5½"
 gerade, straight,
 droite, recta

13-0480
 gebogen, curved,
 courbe, curva



Stieglitz

13-0481
 13,5 cm/5½"
 gerade, straight,
 droite, recta

13-0482
 gebogen, curved,
 courbe, curva



Ralk
 15,0 cm/6"



13-0483
 gerade
 straight
 droite
 recta

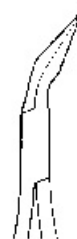

13-0484
 gebogen
 curved
 courbe
 curva

13

**Verschiedene Klemmen
Miscellaneous Forceps
Pinces diverses
Pinzas diversas**



Bulldogklemmen
Bulldog Clamps
Clamps Bulldog
Clamps Bulldog

Arterienklemmen
Hemostatic Forceps
Pinces hémostatiques
Pinzas hemostáticas



14-0497



14-0498

Dieffenbach
6,0 cm/2½"



3,5 cm/1½"
 14-0499 13-0501



Dieffenbach

5,0 cm/2"
 14-0500 13-0502



John Hopkins

14-0505 5,0 cm/2"
 14-0506 6,5 cm/2½"
 14-0507 7,5 cm/3"



14-0503 micro
 14-0508

Hartmann
10,0 cm/4"



14-0504 micro
 14-0509

Arterienklemmen
Hemostatic Forceps
Pinces hémostatiques
Pinzas hemostáticas



Halsted-Mosquito

14-0510	12,5 cm/5"	14-0515
14-0511	14,0 cm/5½"	14-0516
14-0514 micro	12,5 cm/5"	14-0519 micro
gerade		gebogen
straight		curved
droite		courbe
recta		curva



Halsted-Mosquito 1:2

14-0520	12,5 cm/5"	14-0525
14-0521	14,0 cm/5½"	14-0526
14-0529 micro	12,5 cm/5"	14-0530 micro
gerade		gebogen
straight		curved
droite		courbe
recta		curva

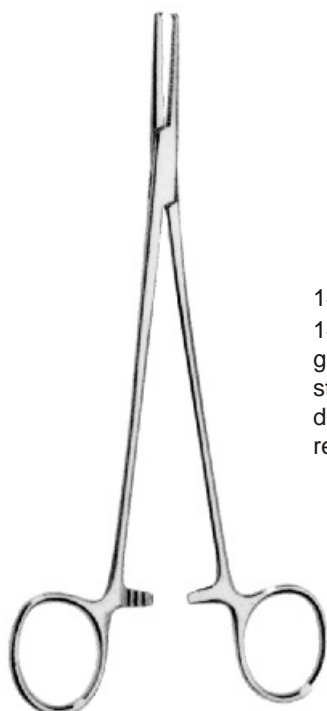

14-0512	18,0 cm/7"
14-0513	21,0 cm/8¼"
gerade	
straight	
droite	
recta	

Halsted-Mosquito

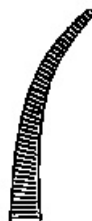

14-0517
14-0518
gebogen
curved
courbe
curva



14-0522	18,0 cm/7"
14-0523	21,0 cm/8¼"
gerade	
straight	
droite	
recta	

Halsted-Mosquito 1:2



14-0527
14-0528
gebogen
curved
courbe
curva



Arterienklemmen
Hemostatic Forceps
Pinces hémostatiques
Pinzas hemostáticas

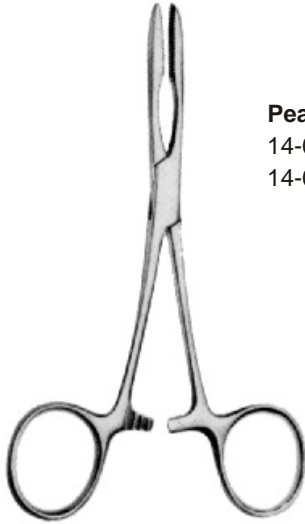

Pean
 14-0531 14,0 cm/5½"
 14-0532 16,0 cm/6¼"



Pean
 14,0 cm/5½"
 fein, delicate, fine, fina

 14-0538
 gerade, straight,
 droite, recta

 14-0540
 gebogen, curved,
 courbe, curva

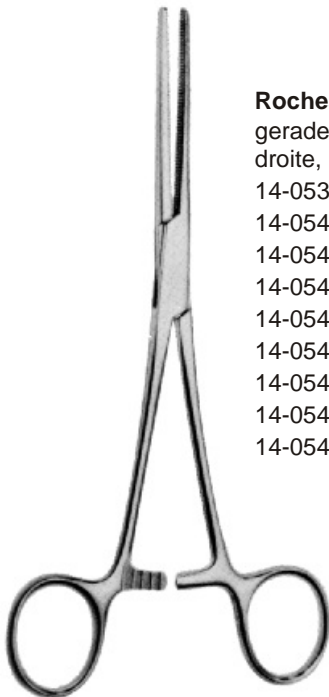

Rochester-Pean
 gerade, straight,
 droite, recta
 14-0533 13,0 cm/5"
 14-0541 14,0 cm/5½"
 14-0542 16,0 cm/6¼"
 14-0543 18,0 cm/7"
 14-0544 20,0 cm/8"
 14-0545 22,0 cm/8¾"
 14-0546 24,0 cm/9½"
 14-0547 26,0 cm/10¼"
 14-0549 30,0 cm/12"

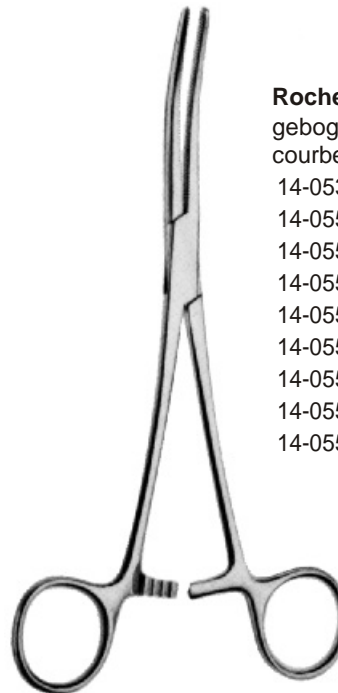

Rochester-Pean
 gebogen, curved,
 courbe, curva
 14-0535 13,0 cm/5"
 14-0551 14,0 cm/5½"
 14-0552 16,0 cm/6¼"
 14-0553 18,0 cm/7"
 14-0554 20,0 cm/8"
 14-0555 22,0 cm/8¾"
 14-0556 24,0 cm/9½"
 14-0557 26,0 cm/10¼"
 14-0559 30,0 cm/12"

Arterienklemmen
Hemostatic Forceps
Pinces hémostatiques
Pinzas hemostáticas



Kocher
 14,0 cm/5½"
 fein, delicate, fine, fina

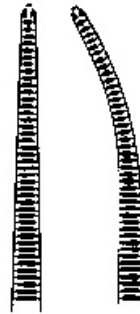

14-0566	14-0568
gerade	gebogen
straight	curved
droite	courbe
recta	curva

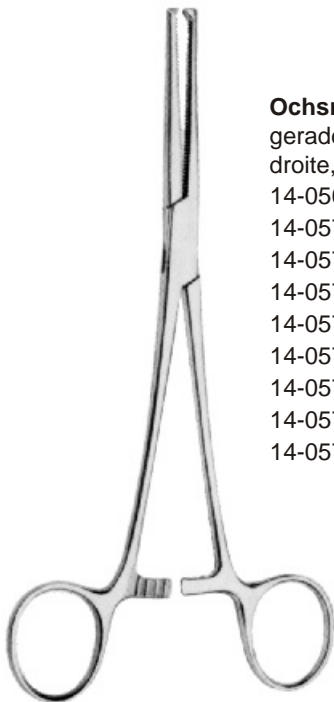

Ochsner-Kocher
 gerade, straight,
 droite, recta

14-0561	13,0 cm/5"
14-0571	14,0 cm/5½"
14-0572	16,0 cm/6¼"
14-0573	18,0 cm/7"
14-0574	20,0 cm/8"
14-0575	22,0 cm/8¾"
14-0576	24,0 cm/9½"
14-0577	26,0 cm/10¼"
14-0579	30,0 cm/12"

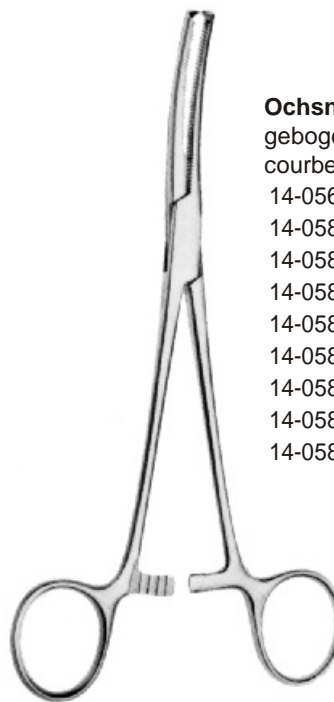

Ochsner-Kocher
 gebogen, curved,
 courbe, curva

14-0563	13,0 cm/5"
14-0581	14,0 cm/5½"
14-0582	16,0 cm/6¼"
14-0583	18,0 cm/7"
14-0584	20,0 cm/8"
14-0585	22,0 cm/8¾"
14-0586	24,0 cm/9½"
14-0587	26,0 cm/10¼"
14-0589	30,0 cm/12"



Arterienklemmen
Hemostatic Forceps
Pinces hémostatiques
Pinzas hemostáticas



Rochester-Carmalt



14-0591
 14-0593
 gerade
 straight
 droite
 recta



16,0 cm/6¼"
 20,0 cm/8"
 14-0595
 14-0597
 gebogen
 curved
 courbe
 curva

14
 1

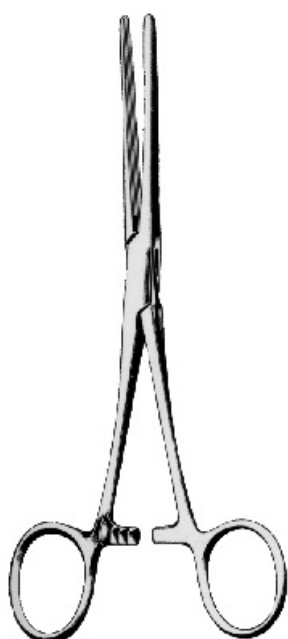

Bainbridge
 15 cm/6"



14-0596
 gerade
 straight
 droite
 recta



14-0598
 gebogen
 curved
 courbe
 curva

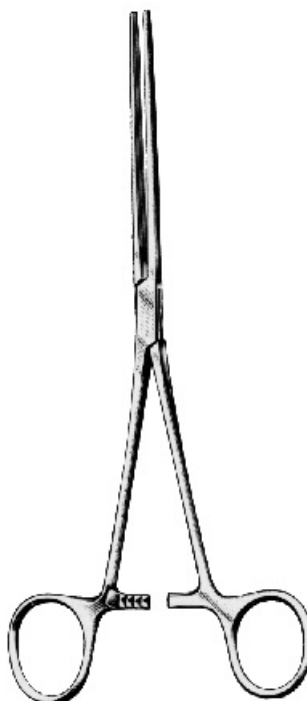

Bainbridge
 18,5 cm/7¼"



14-0599
 gerade
 straight
 droite
 recta



14-0600
 gebogen
 curved
 courbe
 curva

Arterienklemmen
Hemostatic Forceps
Pinces hémostatiques
Pinzas hemostáticas

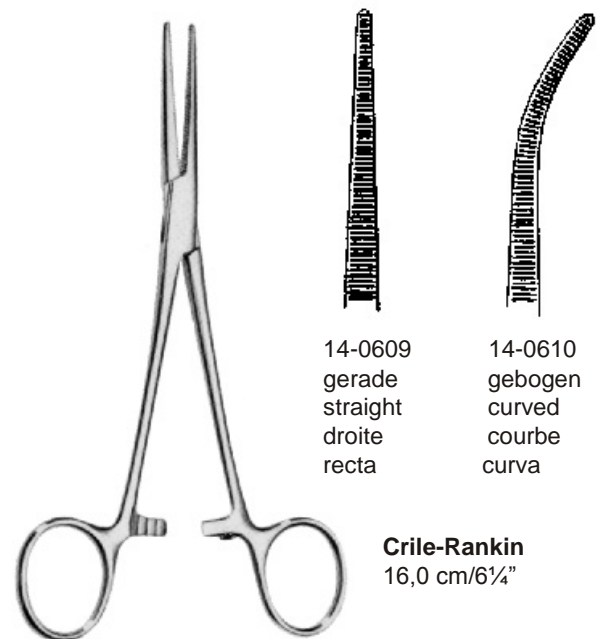
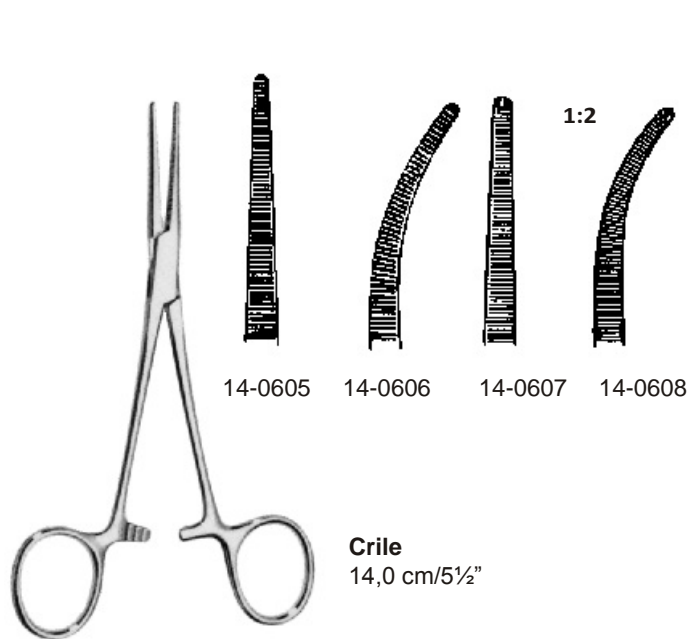
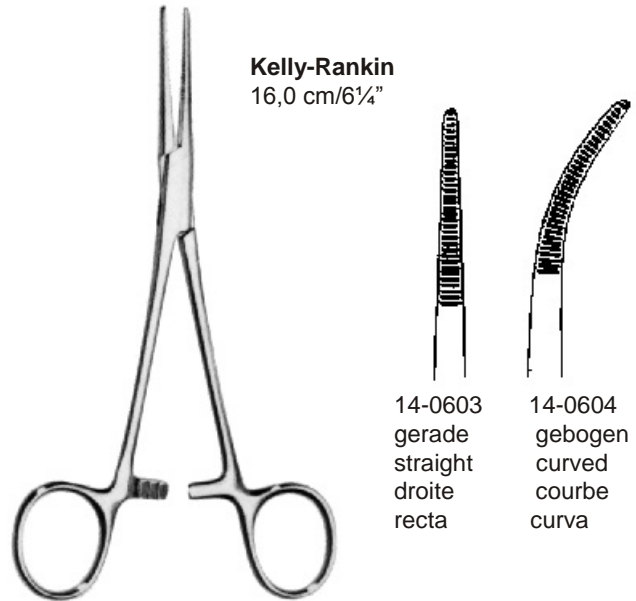
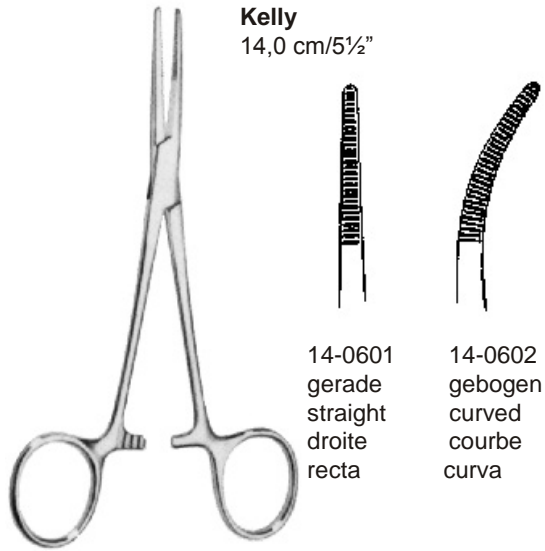

Arterienklemmen
Hemostatic Forceps
Pinces hémostatiques
Pinzas hemostáticas



14-0611
 gerade
 straight
 droite
 recta



14-0612
 gebogen
 curved
 courbe
 curva



Lovelace
 14-0614 15,5 cm/6"

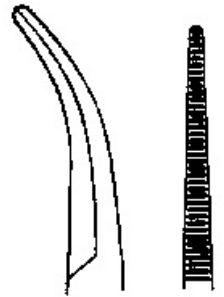
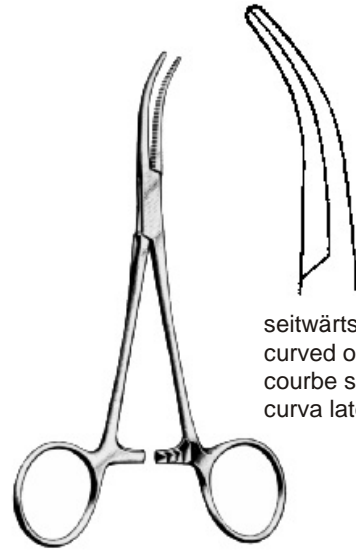

seitwärts gebogen
 curved on side
 courbe sur le côté
 curva lateral

Dandy Crile
 14-0615 14,0 cm/5½"

14



14-0617 14,0 cm/5½"
 14-0619 16,0 cm/6¼"
 gerade
 straight
 droite
 recta



14-0618
 14-0620
 gebogen
 curved
 courbe
 curva

Baby-Crile



14-0621 13,0 cm/5"
 14-0622 14,0 cm/5½"
 14-0623 15,5 cm/6"
 14-0624 18,0 cm/7"
 14-0625 20,0 cm/8"
 14-0626 24,0 cm/9"
 gerade
 straight
 droite
 recta

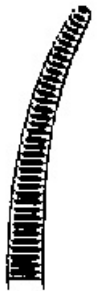

14-0627
 14-0628
 14-0629
 14-0630
 14-0631
 14-0632
 gebogen
 curved
 courbe
 curva

Spencer-Wells

Arterienklemmen
 Hemostatic Forceps
 Pincés hémostatiques
 Pinzas hemostáticas



14-0634
 gerade
 straight
 droite
 recta

Leriche
 15,0 cm/6"

14-0635
 gebogen
 curved
 courbe
 curva



Pennington
 14-0636 15,5 cm/6"
 14-0637 20,0 cm/8"

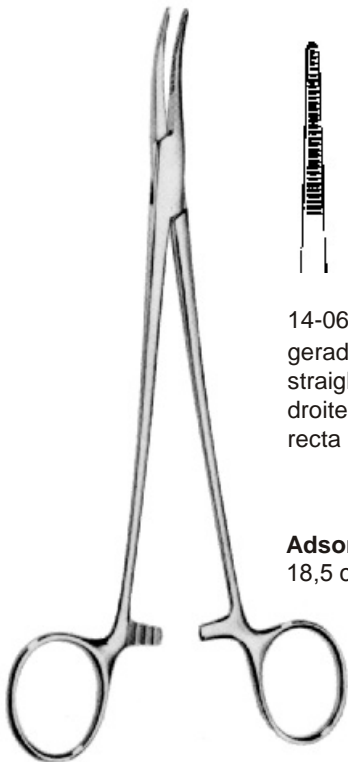

14-0640
 gerade
 straight
 droite
 recta

Adson
 18,5 cm/7¼"

14-0641
 gebogen
 curved
 courbe
 curva

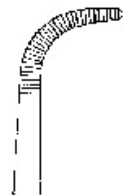

14-0642
 14,0 cm/5½"

14-0643
 18,0 cm/7"

Baby-Adson



Arterienklemmen
Hemostatic Forceps
Pinces hémostatiques
Pinzas hemostáticas

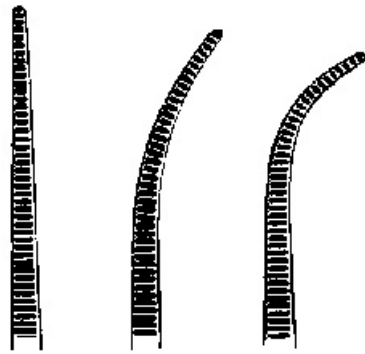
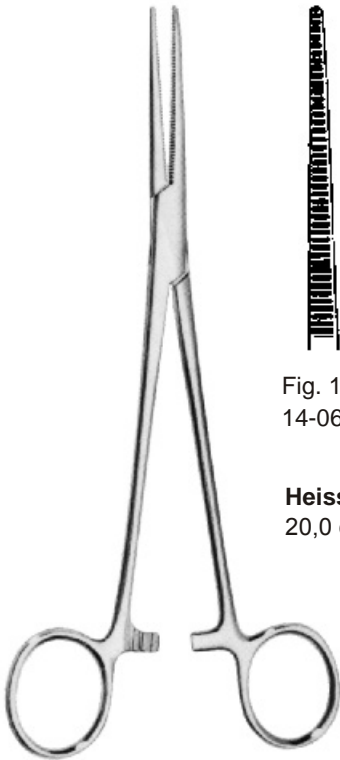

Fig. 1 14-0644
 Fig. 2 14-0645
 Fig. 3 14-0646

Heiss
 20,0 cm/8"

Arterienklemmen
 Hemostatic Forceps
 Pinces hémostatiques
 Pinzas hemostáticas

Präparier- und Ligaturklemmen, Dissecting and Ligature Forceps
 Pinces à disséquer et à ligatures, Pinzas para preparaciones y ligaduras

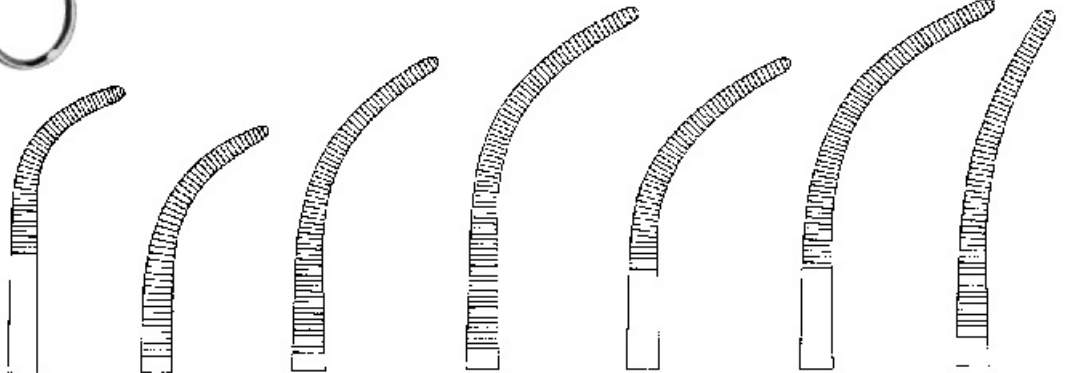

Fig. 1 19,5cm/7¹/₄" 14-0650-01
 Fig. 2 21,0cm/8¹/₄" 14-0650-02
 Fig. 3 22,0cm/8³/₄" 14-0650-03
 Fig. 4 22,5cm/9" 14-0650-04
 Fig. 5 21,5cm/8¹/₂" 14-0650-05
 Fig. 6 22,5cm/9" 14-0650-06
 Fig. 7 22,5cm/9" 14-0650-07

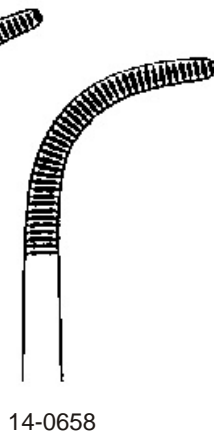
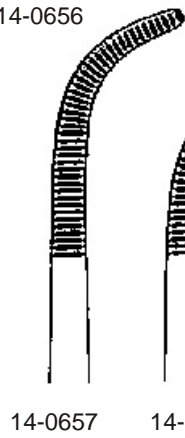
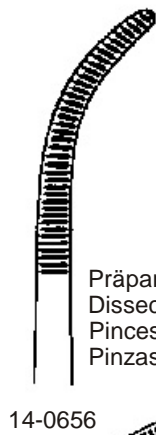
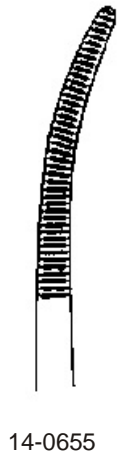
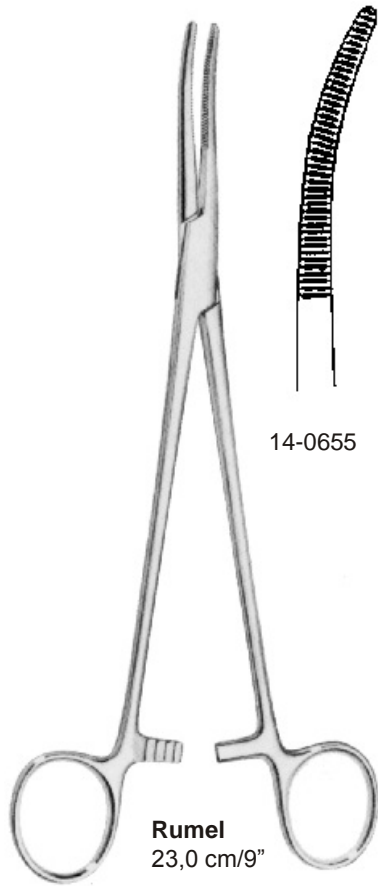

Fig. 1 26,0cm/10¹/₄" 14-0651-01
 Fig. 2 27,0cm/10¹/₂" 14-0651-02
 Fig. 3 27,5cm/10³/₄" 14-0651-03
 Fig. 4 27,5cm/10³/₄" 14-0651-04
 Fig. 5 27,5cm/10³/₄" 14-0651-05
 Fig. 6 28,0cm/11" 14-0651-06
 Fig. 7 27,5cm/10³/₄" 14-0651-07

Overholt-Geissendoerfer

14

Arterienklemmen
 Hemostatic Forceps
 Pincès hémostatiques
 Pinzas hemostáticas



Präparierklemmen
 Dissecting Forceps
 Pincès à disséquer
 Pinzas para preparaciones

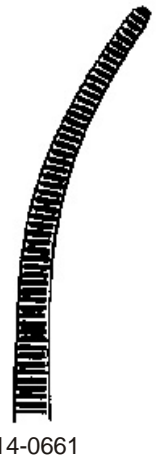
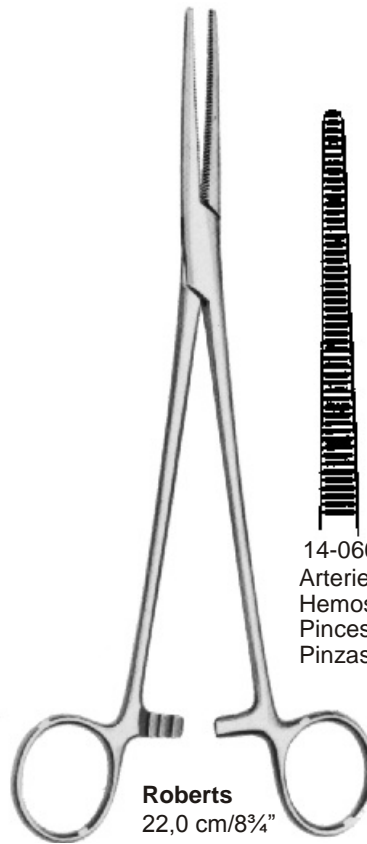

Arterienklemmen
 Hemostatic Forceps
 Pincès hémostatiques
 Pinzas hemostáticas

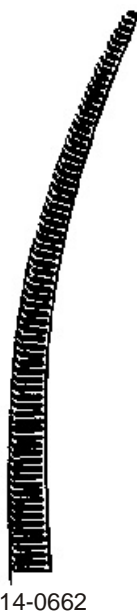

Arterienklemmen
 Hemostatic Forceps
 Pincès hémostatiques
 Pinzas hemostáticas

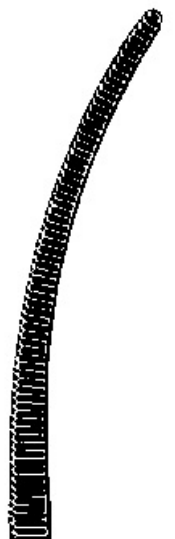
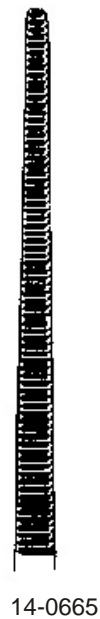
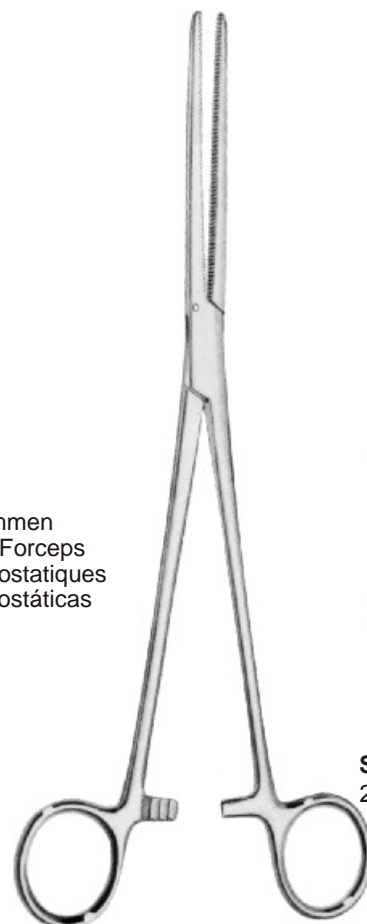

Arterienklemmen
 Hemostatic Forceps
 Pincès hémostatiques
 Pinzas hemostáticas



Bengolea

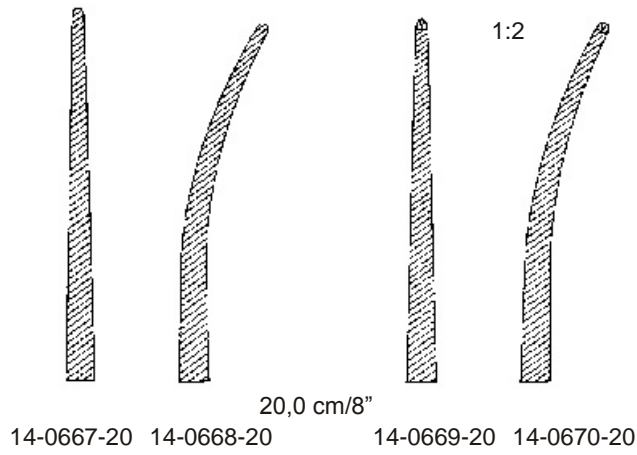

14-0667-20 14-0668-20 20,0 cm/8" 14-0669-20 14-0670-20

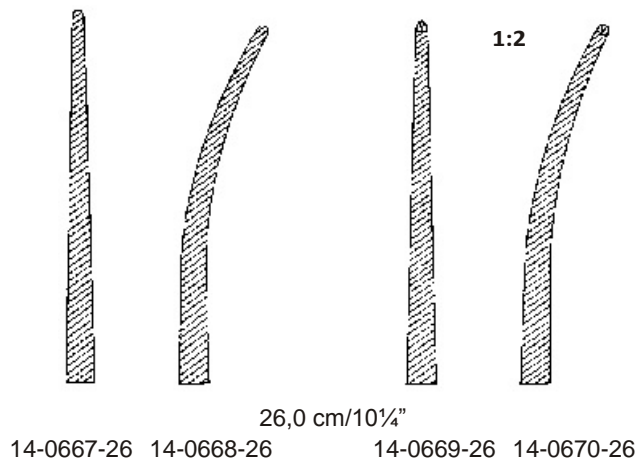

14-0667-26 14-0668-26 26,0 cm/10 1/4" 14-0669-26 14-0670-26



Präparier- und Ligaturklemmen
Dissecting and Ligature Forceps
Pinces à disséquer et à ligatures
Pinzas para preparaciones y ligaduras



Mini-Gemini

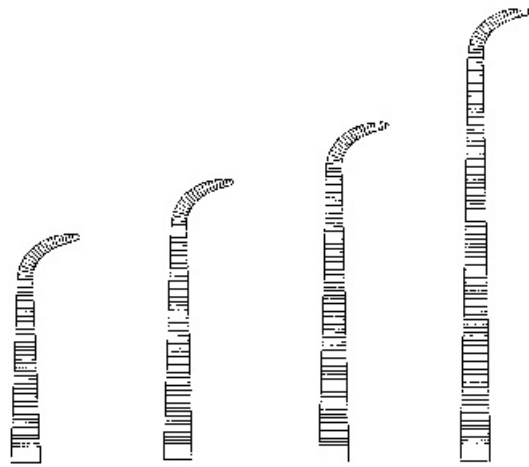

18,0 cm/7"	22,0 cm/8¾"	25,0 cm/10"	28,0 cm/11"
14-0671-18	14-0671-22	14-0671-25	14-0671-28



Gemini

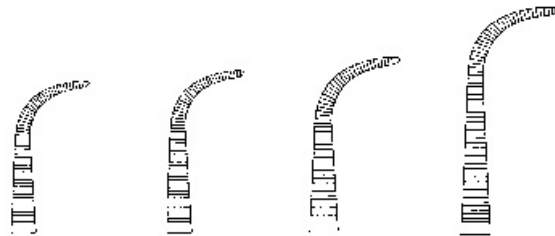

13,0 cm/5"	14,0 cm/5½"	16,0 cm/6¼"	18,0 cm/7"
14-0672-13	14-0672-14	14-0672-16	14-0672-18

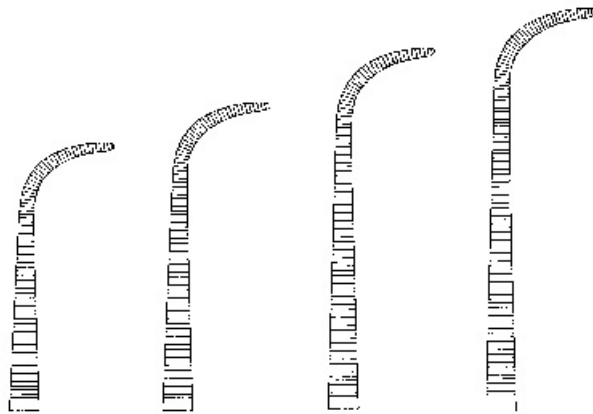

20,0 cm/8"	23,0 cm/9"	25,0 cm/10"	28,0 cm/11"
14-0672-20	14-0672-23	14-0672-25	14-0672-28

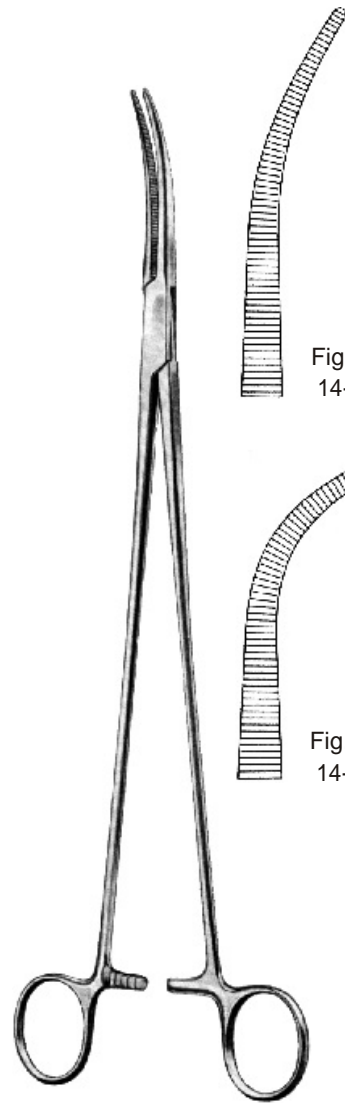

Zenker
29,5 cm/11½"

Fig. 1
14-0673-01

Fig. 2
14-0673-02



Arterienklemmen
 Hemostatic Forceps
 Pinces hémostatiques
 Pinzas hemostáticas



Mixer-Baby
 14-0675 14,0 cm/5½"
 14-0675-18 18,0 cm/7"



Mixer
 14-0676 15,5 cm/6"
 14-0677 19,0 cm/7½"
 13-0678 22,0 cm/8¾"

14

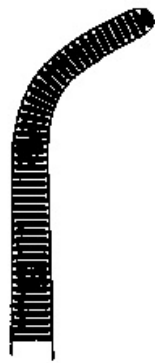

Mixer-O'Shaugnessy
 14-0679 15,5 cm/6"
 14-0680 19,0 cm/7½"

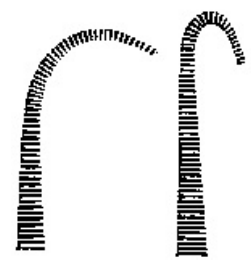

14-0681 14-0682

Negus
 19,0 cm/7½"

Arterienklemmen
 Hemostatic Forceps
 Pincès hémostatiques
 Pinzas hemostáticas

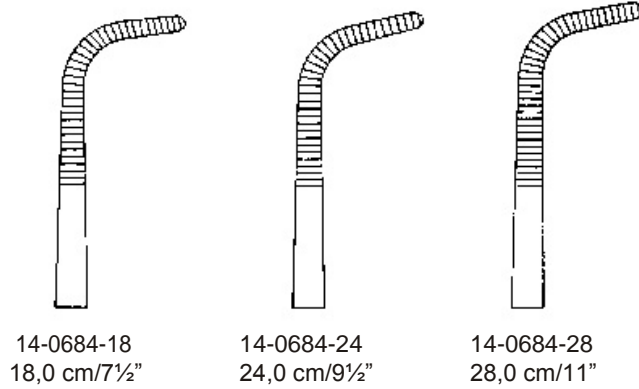

Kantrowitz

Gallenkanalklemmen
 Gall Duct Clamps
 Pincès pour voies biliaires
 Pinzas para conductos biliares

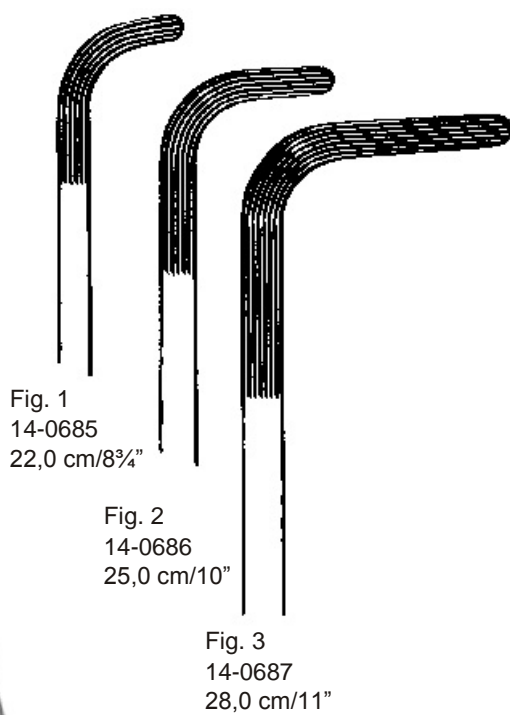
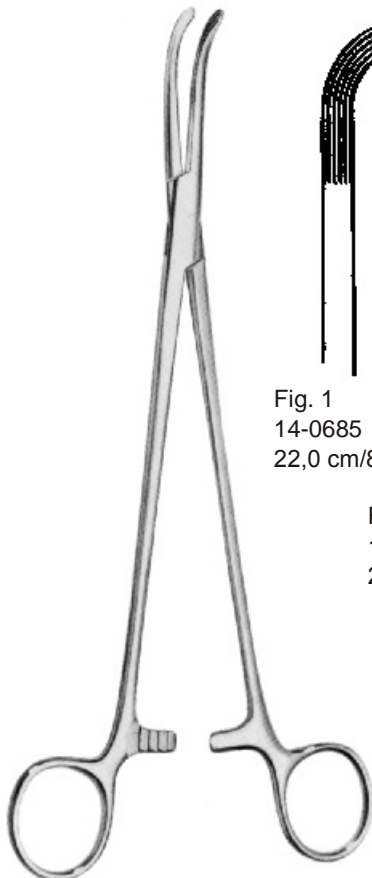

Mixer

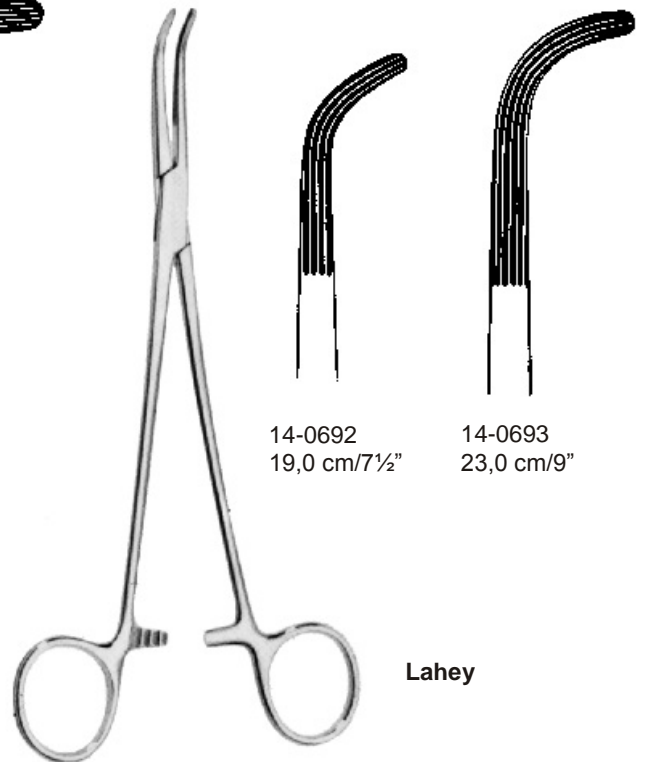

Lahey



Klemmzangen
Clamp Forceps
Pincers clamps
Pinzas-clamps

Hysterektomieklemmen
Hysterectomy Forceps
Pincers à hystérectomie
Pinzas para histerectomia

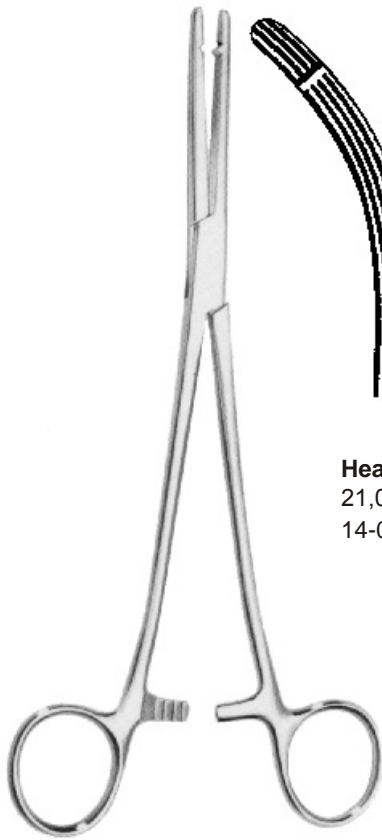

Heaney-Ballentine
21,0 cm/8¼"
14-0712 14-0713



Heaney
14-0716 21,0 cm/8¼"
14-0717 23,0 cm/9"
14-0722
14-0723

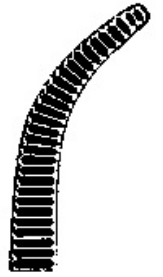
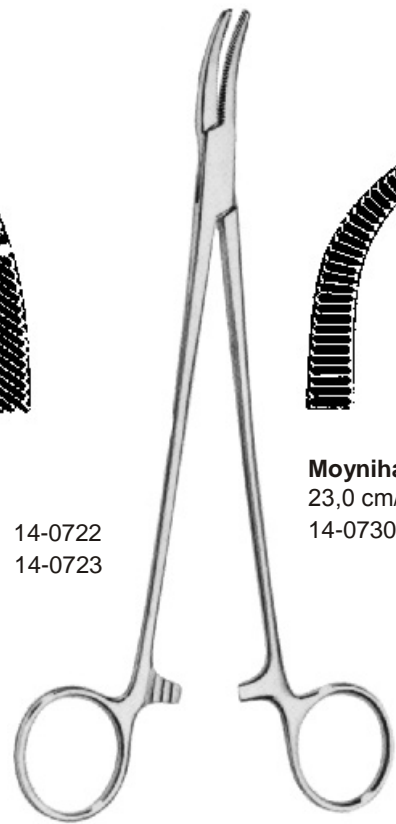

Moynihan
23,0 cm/9"
14-0730

Hysterektomieklemmen
Hysterectomy Forceps
Pincers à hystérectomie
Pinzas para histerectomia

14



Wertheim-Cullen
21,5 cm/8½"
14-0732

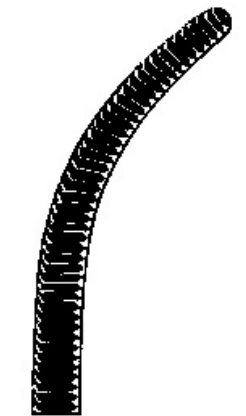

Wertheim
25,0 cm/10"
14-0733

Klemmzangen **Hysterektomieklemmen**
Clamp Forceps **Hysterectomy Forceps**
Pinces clamps **Pinces à hystérectomie**
Pinzas-clamps **Pinzas para histerectomia**

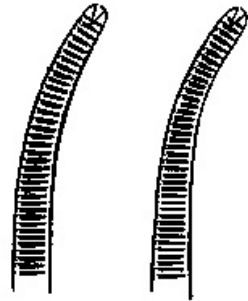

Wertheim
 22,0 cm/8³/₄" 23,0 cm/9"
 14-0734 14-0735

Klemmzangen
 Clamp Forceps
 Pinces clamps
 Pinzas-clamps

Peritoneumklemmen, Peritoneal Clamp Forceps, Pinces pour péritoine, Pinzas para peritoneo

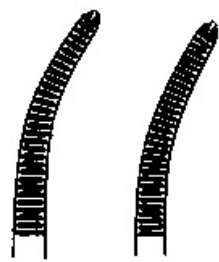

14-0737 14-0738

Mikulicz
 20,0 cm/8"

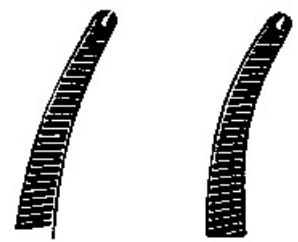
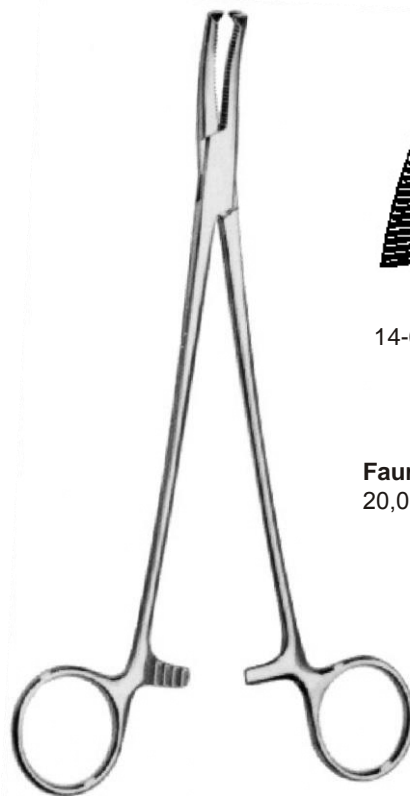

14-0739 14-0740

Faure
 20,0 cm/8"



Tuchklemmen
Towel Forceps
Pinces à champs
Pinzas de campo



Schädel
 9,0 cm/3½"

14-0761
 gebogen
 curved
 courbe
 curva



Jones
 14-0762 5,5 cm/2¼"
 14-0763 9,0 cm/3½"



Doyen
 18,0 cm/7"
 14-0764

14



Peers
 14,5 cm/5¾"
 14-0770

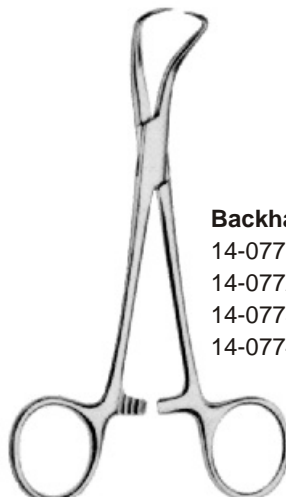

Backhaus
 14-0771 9,0 cm/3½"
 14-0772 11,0 cm/4½"
 14-0773 13,0 cm/5"
 14-0774 15,0 cm/6"

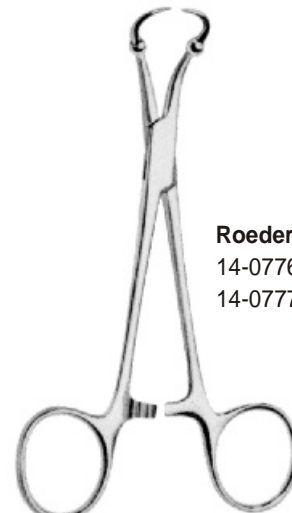

Roeder
 14-0776 13,0 cm/5"
 14-0777 15,0 cm/6"

Tuchklemmen
Towel Forceps
Pinces à champs
Pinzas de campo



Bernhard
 16,0 cm/6¼"
 14-0778



Lane
 20,0 cm/8"
 14-0780



Lorna
 14-0781 10,0 cm/4"
 14-0782 13,0 cm/5"



Ombredanne
 13,5 cm/5½"
 14-0783

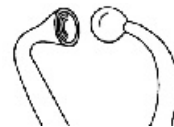

14-0785 11,0 cm/4½"
 14-0786 13,0 cm/5"
 Kugel/Pfanne
 Ball/Socket
 boule/poêle
 bola/paila



14-0787 11,0 cm/4½"
 14-0788 13,0 cm/5"
 Kugel/Kugel
 Ball/Ball
 boule/boule
 bola/bola



Tuchklemmen
Towel Forceps
Pinces à champs
Pinzas de campo

Schlauchklemmen
Tubing Clamps
Pinces presse-tube
Pinzas para tubos

Tuchklemmen, Towel Forceps, Pinces à champs, Pinzas de campo

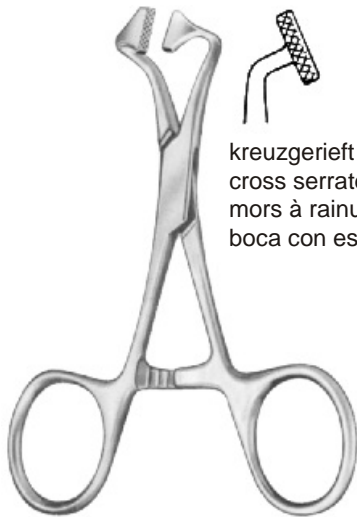

kreuzgerieft
 cross serrated
 mors à rainures croisées
 boca con estrías cruzadas

Thomas
 14-0788-10 10,0 cm/4"
 14-0788-13 13,0 cm/5"

Schlauchklemmen, Tubing Clamps, Pinces presse-tube, Pinzas para tubos

14

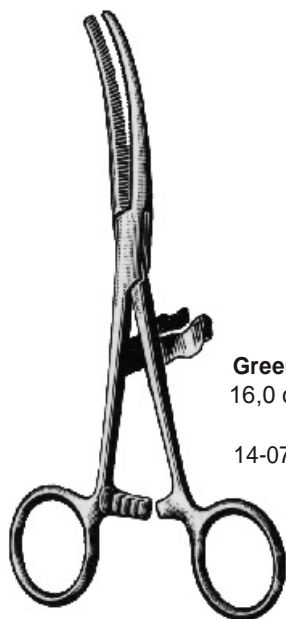

Green
 16,0 cm/6¼"
 14-0789



Presbyterian
 16,0 cm/6½"
 14-0790
 glatt
 smooth
 mousse
 lisse

Schlauchklemmen
 Tubing Clamps
 Pincas presse-tube
 Pinzas para tubos

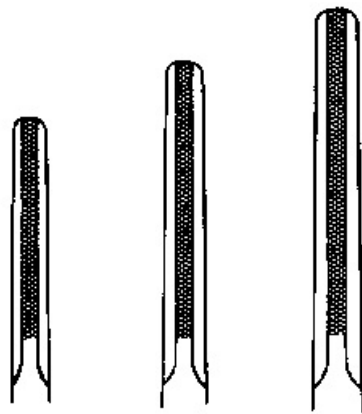

14,0 cm/5½" 14-0791
 18,0 cm/7" 14-0792
 20,0 cm/8" 14-0793

ohne U
 without guard
 sans protection
 sin protección

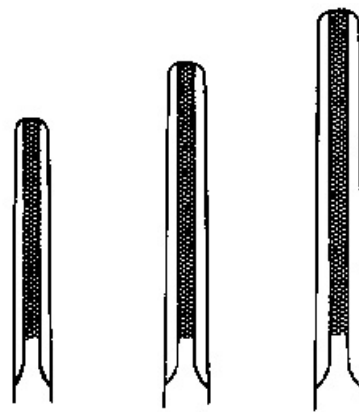

14,0 cm/5½" 14-0796
 18,0 cm/7" 14-0797
 20,0 cm/8" 14-0798

mit U
 with guard
 avec protection
 con protección



Korn-(Polypen-) zangen
Polypus and Dressing Forceps
Pinces à pansements et à polypes
Pinzas para pólipos y vendajes

Tupferzangen
Cotton Swab Forceps
Pinces à tampons
Pinzas para tampones



Lister
 Sinusklemmen
 Sinus Forceps
 Pinces à sinus
 Pinzas para seno
 14-0825 13,0 cm/5"
 14-0826 16,0 cm/6¼"
 14-0827 18,0 cm/7"

Korn-(Polypen-) zangen, Polypus and Dressing Forceps
 Pinces à pansements et à polypes, Pinzas para pólipos y vendajes



14-0821
 gerade, straight
 droite, recta

Gross
 20,0 cm/8"

14-0822
 gebogen, curved
 courbe, curva

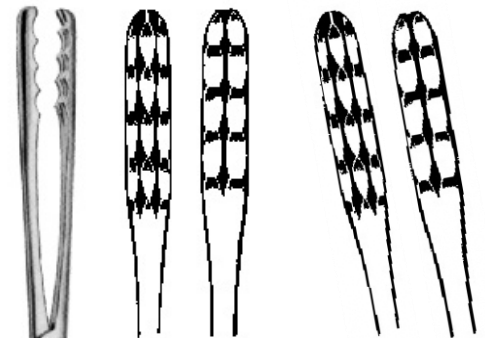

14-0851	22,0 cm/8¾"	14-0853
14-0852	25,0 cm/10"	14-0854
gerade		gebogen
straight		curved
droite		courbe
recta		curva

Tupferzangen
Cotton Swab Forceps
Pinces à tampons
Pinzas para tampones

Ulrich

Korn-(Polypen-) zangen
Polypus and Dressing Forceps
Pinces à pansements et à polypes
Pinzas para pólipos y vendajes

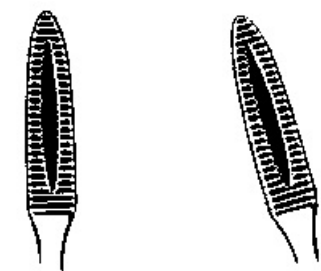

14-0855 22,0 cm/8¾" 14-0857
 14-0856 25,0 cm/10" 14-0858

Korn-(Polypen-) zangen
 Polypus and Dressing Forceps
 Pinces à pansements et à polypes
 Pinzas para pólipos y vendajes

Maier

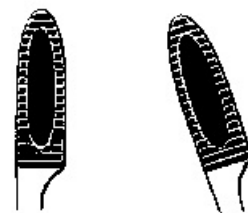
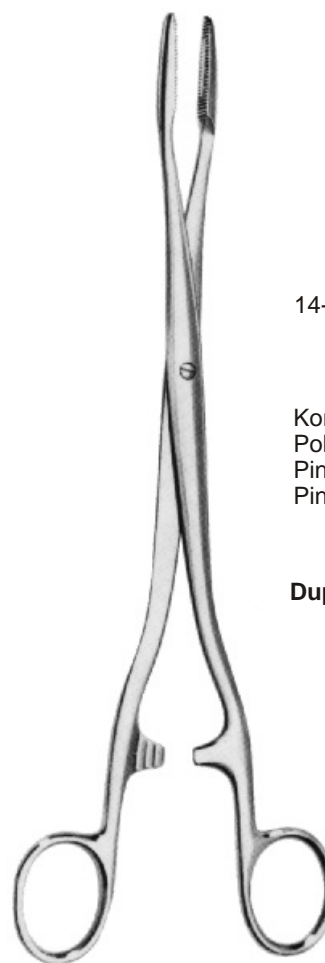

14-0861 25,0 cm/10" 14-0862

Korn-(Polypen-) zangen
 Polypus and Dressing Forceps
 Pinces à pansements et à polypes
 Pinzas para pólipos y vendajes

Duplay

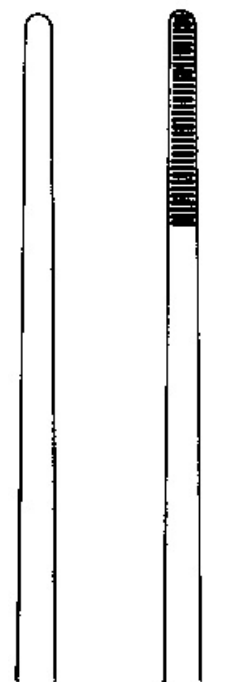

14-0865 14-0866

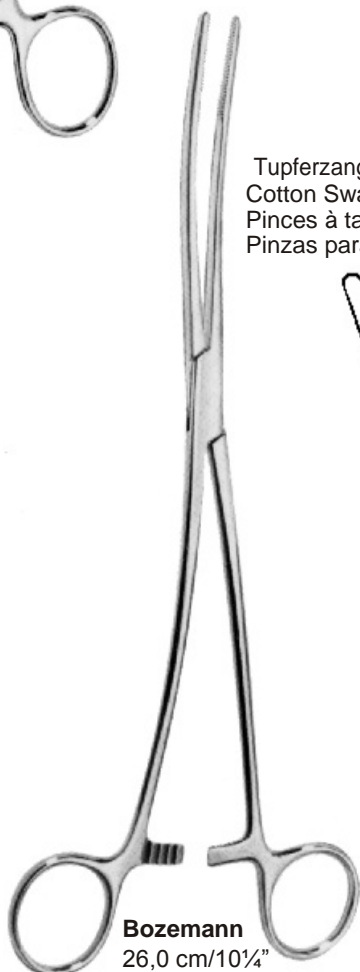

Tupferzangen
 Cotton Swab Forceps
 Pinces à tampons
 Pinzas para tampones

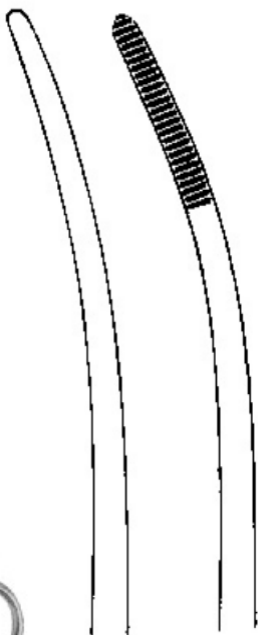

14-0867 14-0868

Bozemann
 26,0 cm/10¼"

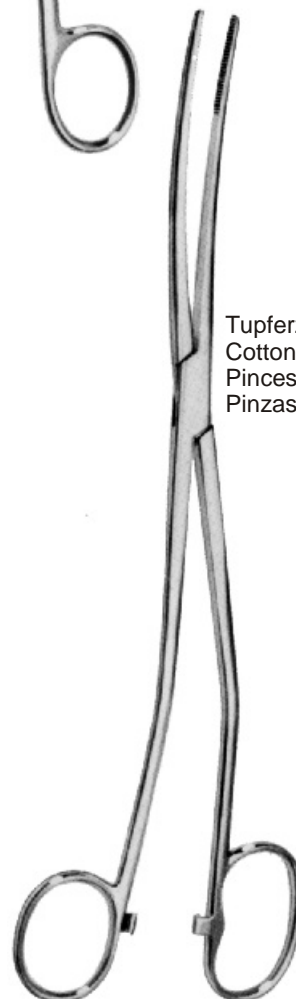

Tupferzangen
 Cotton Swab Forceps
 Pinces à tampons
 Pinzas para tampones

Bozemann-Douglas
 26,0 cm/10¼"
 14-0869



Tupferzangen
Cotton Swab Forceps
Pinces à tampons
Pinzas para tampones

Schwammzangen
Sponge Holding Forceps
Pinces à éponges
Pinzas porta-esponjas

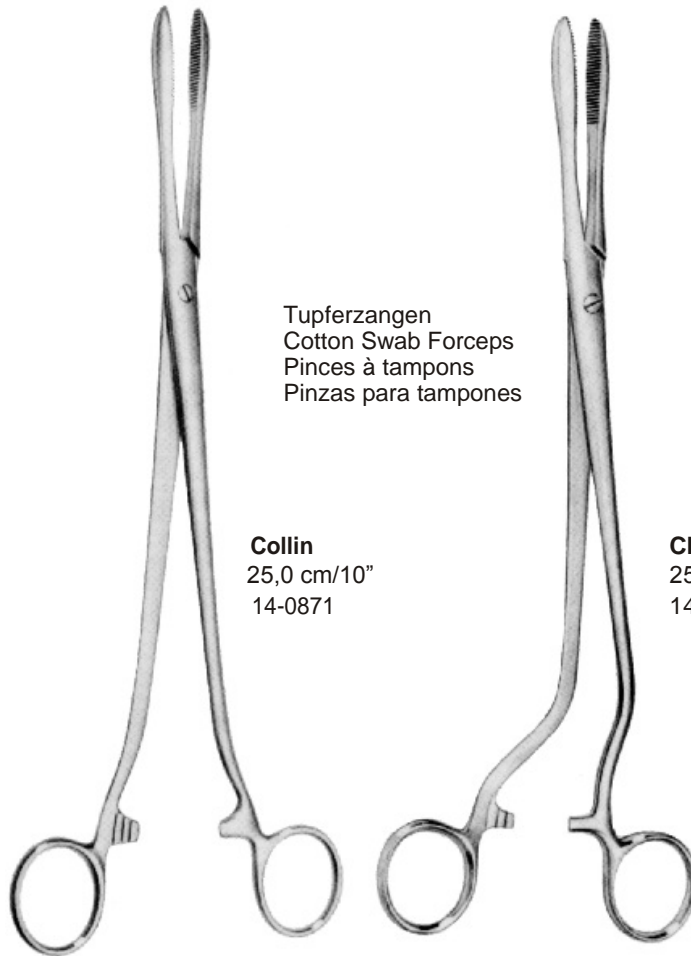

Tupferzangen
 Cotton Swab Forceps
 Pinces à tampons
 Pinzas para tampones

Collin
 25,0 cm/10"
 14-0871

Cheron
 25,0 cm/10"
 14-0873

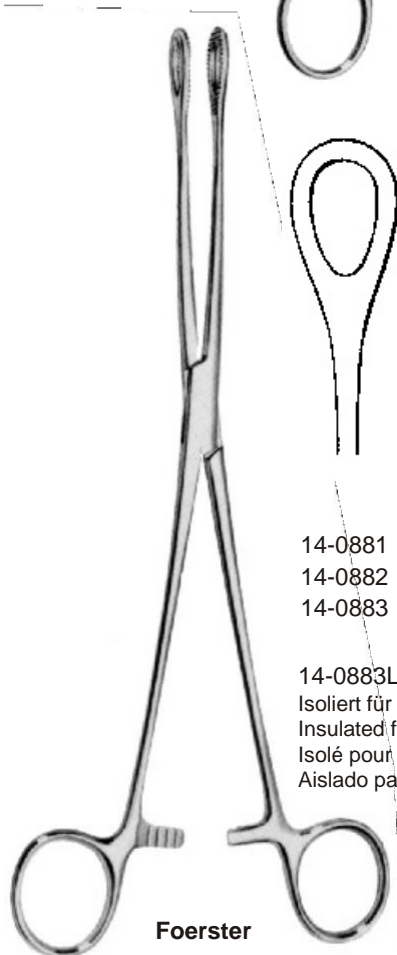

Foerster

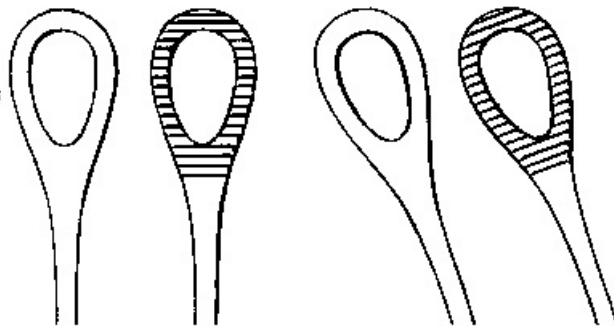

14-0881	14-0884	18,0 cm/7"	14-0887	14-0890
14-0882	14-0885	20,0 cm/8"	14-0888	14-0891
14-0883	14-0886	25,0 cm/10"	14-0889	14-0892

14-0883L 25,0 cm/10"
 Isoliert für Laser- und Elektrochirurgie
 Insulated for Laser- and Electrosurgery
 Isolé pour les interventions au laser et électrochirurgical
 Aislado para láser y electrocirugía

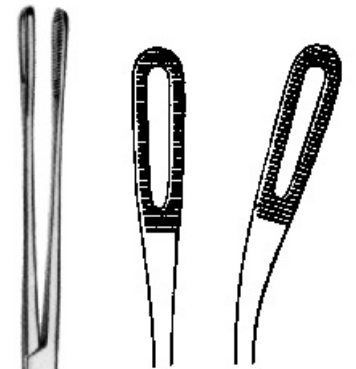

14-0893 14-0894

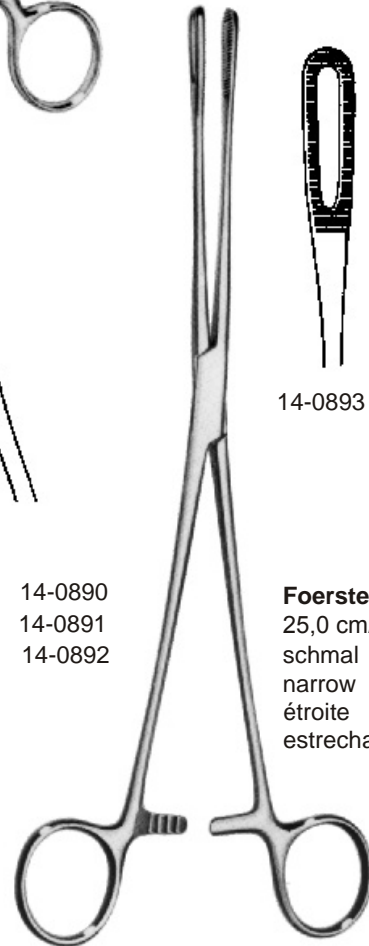

Foerster
 25,0 cm/10"
 schmal
 narrow
 étroite
 estrecha



Schwammzangen
Sponge Holding Forceps
Pinces à éponges
Pinzas porta-esponjas

Sterilisierzangen
Sterilizing Forceps
Pinces à stérilisation
Pinzas para esterilización

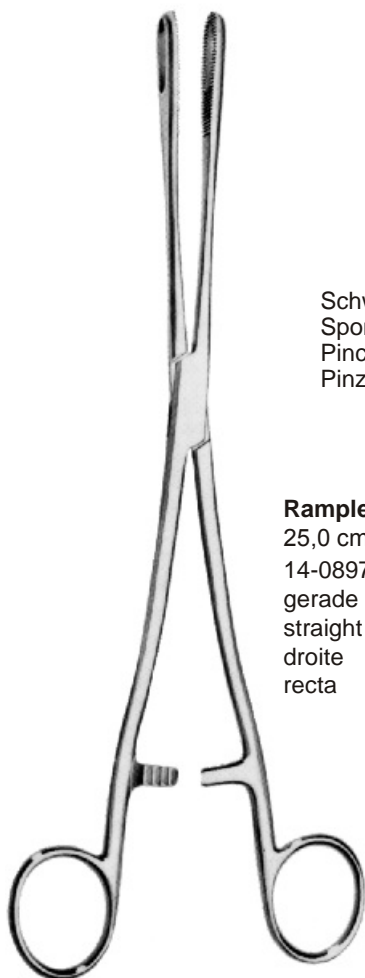

Schwammzange
 Sponge Holding Forceps
 Pinces à éponges
 Pinzas porta-esponjas

Rampley
 25,0 cm/10"
 14-0897 gerade
 straight
 droite recta

14-0898 gebogen
 curved
 courbe curva

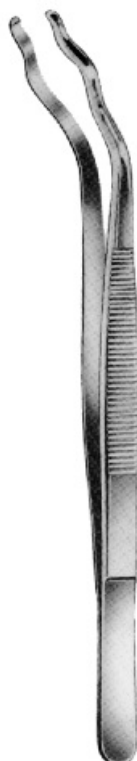

Sterilisierzange
 Sterilizing Forceps
 Pinces à stérilisation
 Pinzas para esterilización

Davis
 Sterilisierpinzette
 Sterilizing Forceps
 Pinces à stérilisation
 Pinzas para esterilización
 14-0901 16,0 cm/6¼"
 14-0902 20,0 cm/8"
 14-0903 24,0 cm/9½"

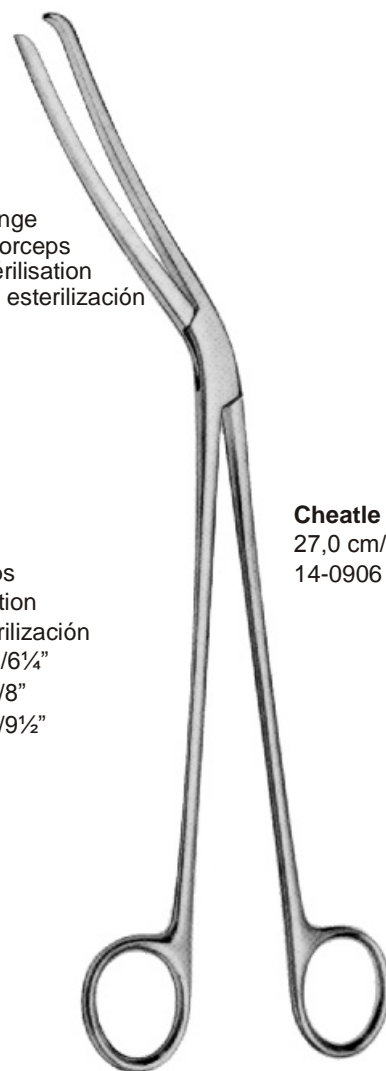

Cheatle
 27,0 cm/10½"
 14-0906

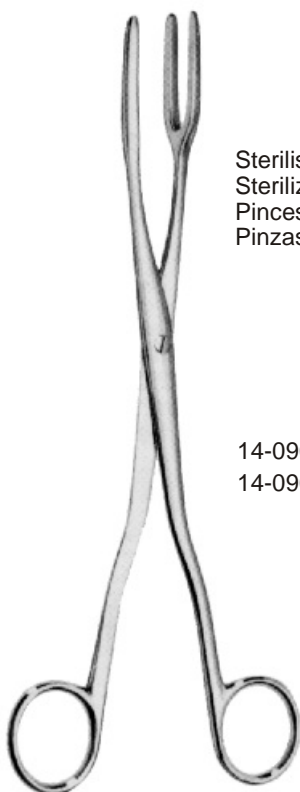

Sterilisierzange
 Sterilizing Forceps
 Pinces à stérilisation
 Pinzas para esterilización

14-0907 20,0 cm/8"
 14-0908 30,0 cm/12"

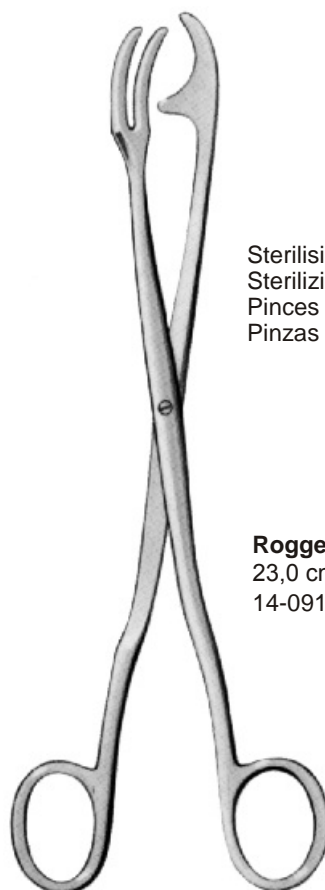

Sterilisierzange
 Sterilizing Forceps
 Pinces à stérilisation
 Pinzas para esterilización

Rogge
 23,0 cm/9"
 14-0910



15



Hautstanzen
Dermal Punches
Trépanos cutanés
Trépanos cutáneos

Keys

- 15-0922 (2 mm)
- 15-0923 (3 mm)
- 15-0924 (4 mm)
- 15-0925 (5 mm)
- 15-0926 (6 mm)
- 15-0927 (7 mm)
- 15-0928 (8 mm)

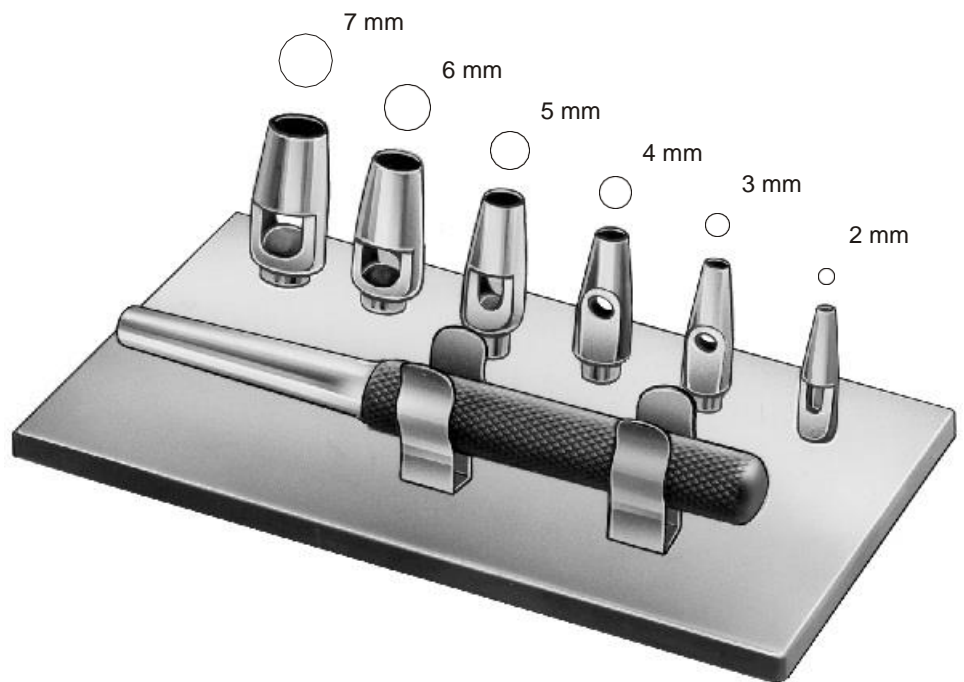

Keys Set

15-0930
 Hautstanze komplett, mit 6 auswechselbaren Stanzköpfen
 Dermal Punch complete, with 6 interchangeable tips
 Trépanos cutanés complets, avec 6 embouts interchangeables
 Trépanos cutáneos completos, con 6 puntas intercambiables

Dermatome
Dermatomes
Dermatomes
Dermátomos



Schink

1/2

15-0950

30,0 cm/12"

Dermatom, einstellbar von 0,1 - 2,0 mm, komplett, mit 1 auswechselbarer Klinge und 2 Spannplatten

Dermatome, adjustable from 0,1 to 2,0 mm, complete, with 1 interchangeable blade and 2 skin straightening blades

Dermatome, réglable en épaisseur de 0,1 à 2,0 mm, complet, avec 1 lame interchangeable et 2 plaques pour tendre la peau

Dermátomo, graduable de 0,1 hasta 2,0 mms, completo, con 1 hoja intercambiable y 2 placas para extender la piel



15-0951

1/2

Ersatzklinge, allein

Spare blade only

Lame de rechange, seule

Hoja de repuesto, suelta

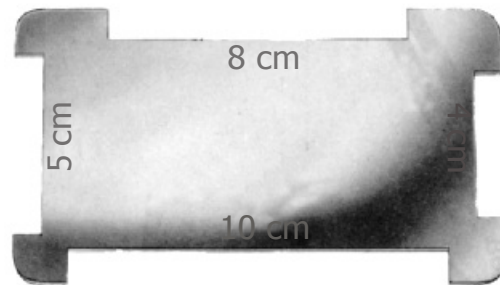

15-0952

1/2

Spannplatte, allein

Skin straightening plate only

Plaque pour tendre la peau, seule

Placa para extender la piel, suelta



Silver

1/2

15-0953

19,0 cm/7 1/2"

Dermatom

Dermatome

Dermatome

Dermátomo

Häkchen, Lupuslöffel
Hooklets, Lupus Currettes
Crochets, Curettes pour les lupus
Ganchos, Curetas para lupus



Gillies
 18,0 cm/7"



Kilner
 15,0 cm/6"
 15-0961-15



Vidal
 Lupuschaber
 Lupus scraper
 Rugine pour le lupus
 Legra para lupus
 14,0 cm/5½"

Lupusküretten
Lupus curettes
Curettes pour le lupus
Curetas para lupus

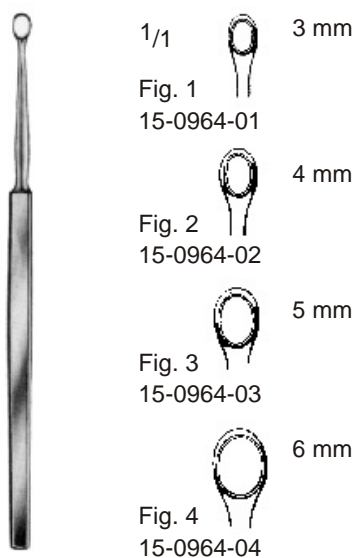

Fox
 14,0 cm/5½"

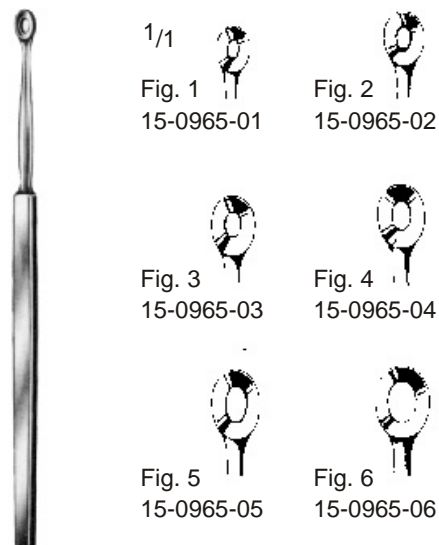

Wolff
 14,0 cm/5½"

Lupuslöffel
Lupus curettes
Curettes pour le lupus
Curetas para lupus



Komedoneninstrumente
Comedo Extractors
Tire-comédons
Saca-comedones



Unna
 14,5 cm/5½"
 oval, oval
ovale, oval
 15-0966

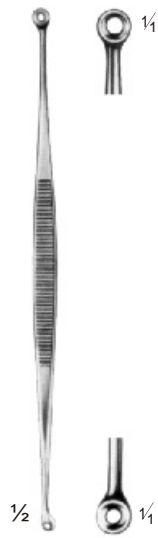

Unna
 14,5 cm/5½"
 rund, round
 ronde, redondo
 15-0967



Saalfeld
 11,0 cm/4"
 15-0968-11



Saalfeld
 14,5 cm/6"
 15-0968-14



Schamberg
 9,5 cm/4"
 15-0969

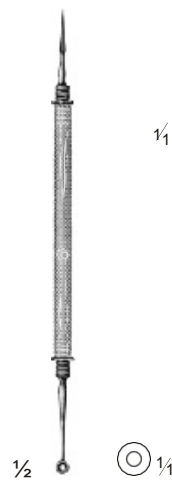

Unna-Vidal
 11,5 cm/4½"
 15-0970



**Messer, Skalpelle Knives,
Scalpels Couteaux,
Bistouris Cuchillos,
Bisturías**

